

AS40-CD Conveyors

Installation & Maintenance Instructions



Contents

Warnings	2
Tools	3
Installation	4
Maintenance	11
Recommended Spare Parts	18
Troubleshooting	19
Exploded Views	20
Warranty Information	29
Service Record	32



QC Conveyors
4057 Clough Woods Dr.
Batavia, OH 45103 USA

+1 (513) 753-6000
qcconveyors.com

Warnings



When used improperly, conveyor rollers can pinch or maim



Lock out power before servicing conveyor

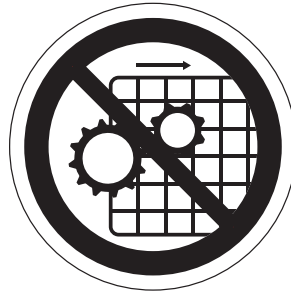

Do not use with guards removed



Read this manual before operating

DANGER

WARNING

WARNING

WARNING



Climbing, sitting, walking or riding on conveyor at any time will cause severe injury or death

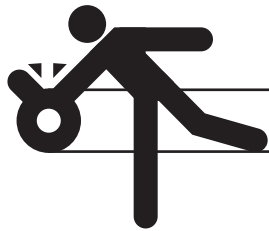

Exposed moving parts can cause severe injury; DISCONNECT POWER before removing guard



Equipment may start without warning - can cause severe injury. KEEP AWAY



Servicing moving or energized equipment can cause severe injury LOCK OUT POWER

Tools

► Required Tools

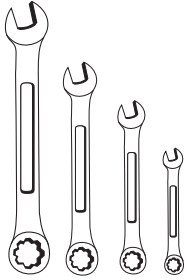

Set of Metric Wrenches (3mm-13mm)

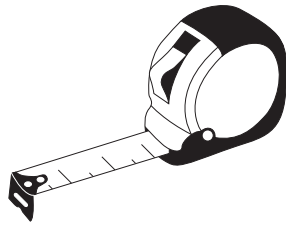

Tape Measure



10" Adjustable Wrench

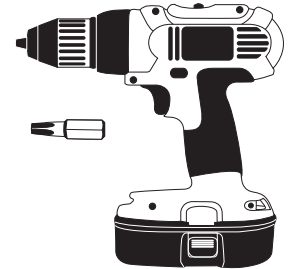

Screw Gun and T-30 Torx Bit

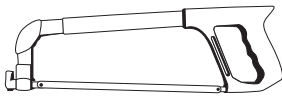

Aluminum cutting hack saw or equivalent



Set of Metric allen wrenches (3mm, 4mm & ball head 5mm)



Bubble level

► Optional Tools

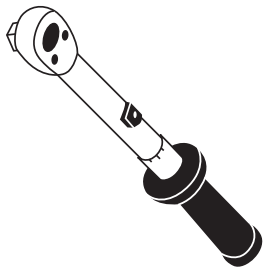

3/8" Torque wrench

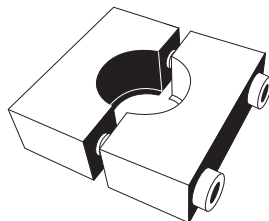

QC Conveyors bearing removal tool (part# 1A0077A)

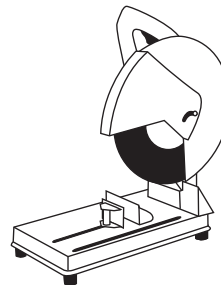

Electric Chop Saw

Installation

► Check Your Shipment

Before opening the shipment, visually inspect the outside of the crate/box for shipping damage. Carefully unpack the crate/box, inspecting for component damage which may have occurred inside the packing materials. Contact the carrier and QC Conveyors regarding any damage that may have occurred during shipment. Check the contents of your shipment against the supplied packing slip and inform QC Conveyors of any discrepancies.

► General Sequence of Installation

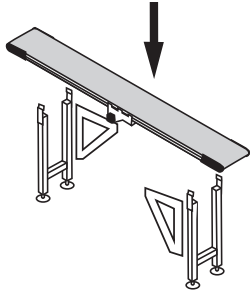

1 Mount conveyor to stands or compatible mounting brackets.

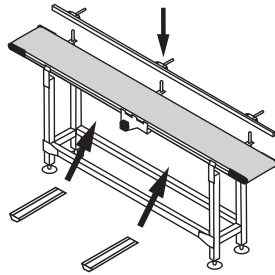

2 Attach sides, guides or underside idlers to conveyor and adjust as needed.

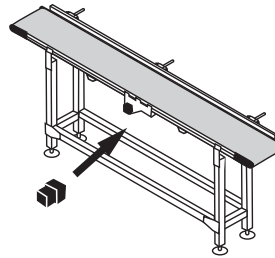

3 Install drive motor to mounting package. (If not already installed)

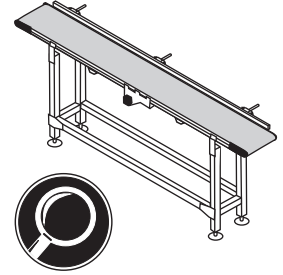

4 Lag conveyor to floor / engage caster locks and inspect conveyor before use.

► Assistance

If you need assistance, please contact QC Conveyors customer service department Monday through Friday, 8am-5pm EST at (513) 753-6000. In addition, your local distributor has been trained at the factory and can provide support in many ways. You can also visit our website - qcconveyors.com - for additional information and technical documents.

Stand Installation

Mounting Aluminum Stands to Conveyor

► Mounting Aluminum Exact Width Stands

Stands should be placed as close to ends of conveyor as possible. Stands may be placed a maximum of 10' apart for conveyors 6" wide or less with a load less than 20 lbs.; conveyors 8"-12" wide with a load less than 25 lbs.; conveyors 18"-24" wide. For all other conveyors, stands should be placed a maximum of 6' apart.

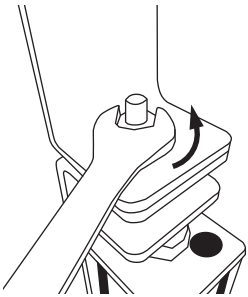

1 Remove the nuts holding the stand attachment brackets to the top of the stand and remove the brackets.

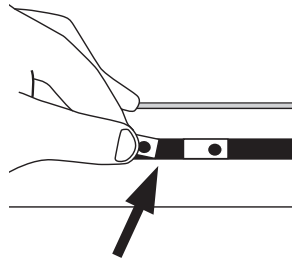

2 Insert drop in nuts into t-slot on conveyor frame.

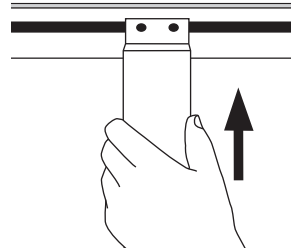

3 Attach stand attachment brackets to conveyor using a 5mm allen wrench.

For Conveyors 6" wide or less:
flange should point outboard;
spacer must be installed between
stand attachment bracket and
conveyor frame.

For conveyors more than 6" wide:
flange should point inboard; no
spacer is necessary

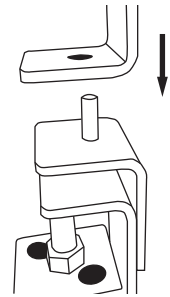

4 Place stand attachment brackets atop stands.

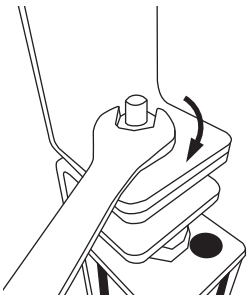

5 Replace nuts and tighten.

► Stand Height Adjustment

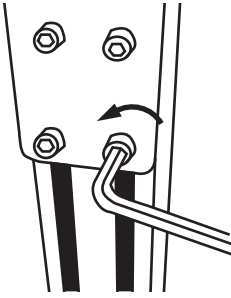

1 Loosen four screws in each stand bracket using a 5mm allen wrench.

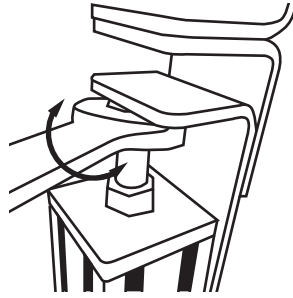

2 Adjust stand height by turning bolt using a 3/4" wrench. Turn clockwise to lower or counter-clockwise to raise. Ensure conveyor is level.

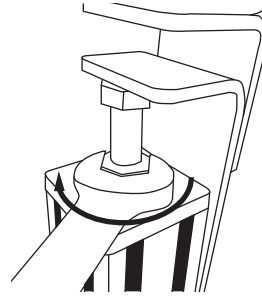

3 Tighten jam nut against top plate of stand.

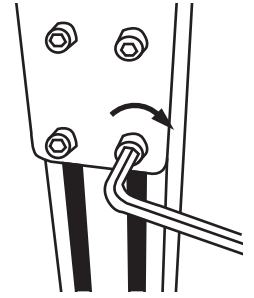

4 Tighten four screws in each stand bracket using a 5mm allen wrench.

► Installing Cross Ties

For applications using a single cross tie, the cross tie should be installed between the cross bars of the stands. For applications using two cross ties, the cross ties should be installed between the uprights of the stands. The installation process is the same for each.

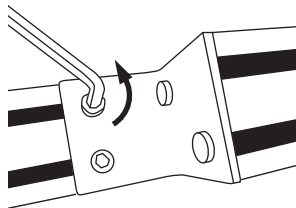

x4

1 Using a 5mm allen wrench, loosen two socket head cap screws in each cross tie adjustment plate.

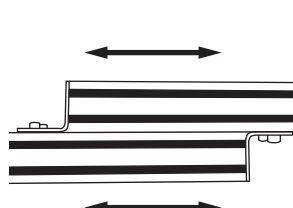

2 Slide adjustable cross tie pieces to fit between stands.

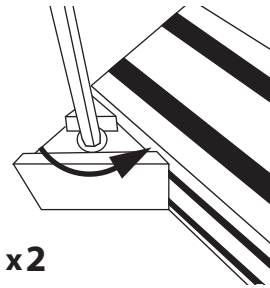

x2

3 Loosen triangular Quick Clamp on each end of cross tie.

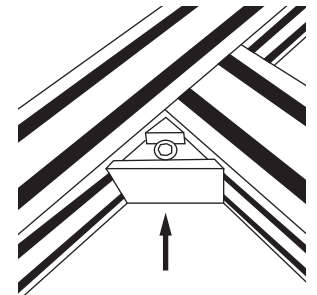

4 Ensuring the socket head cap screw is facing you, slide Quick Clamp into tee slot at desired mounting position.

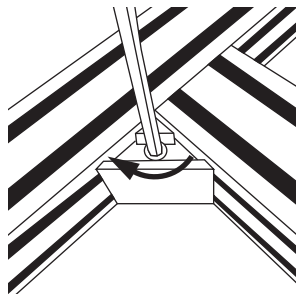

5 Using a 5mm allen wrench, tighten Quick Clamp.

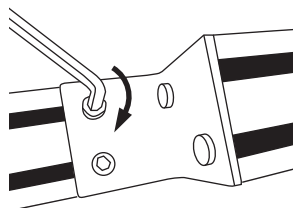

x4

6 Using a 5mm allen wrench, tighten two socket head cap screws in each cross tie adjustment plate.

► Mounting Angle Braces

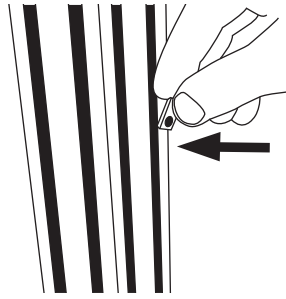

1 Insert drop in nut into inner stand leg t-slot.

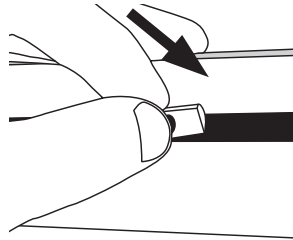

2 Insert drop in nut into conveyor frame's t-slot.

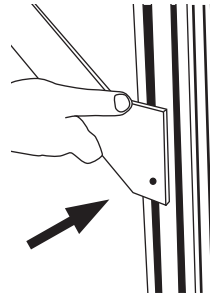

3 Align angle brace over drop in nut in stand.

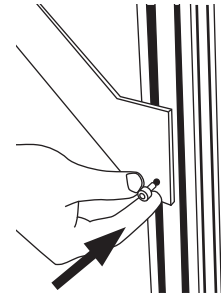

4 Insert socket head cap screw through angle brace and into drop in nut on stand (do not fully tighten).

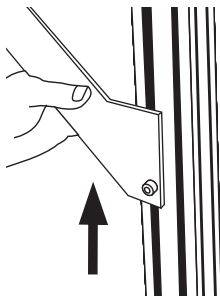

5 Slide up and align angle brace with drop in nut in frame.

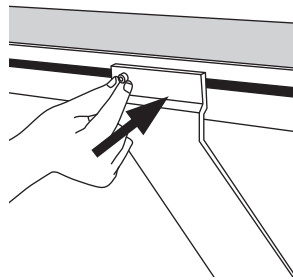

6 Insert socket head cap screw through angle brace and into nut in conveyor frame.

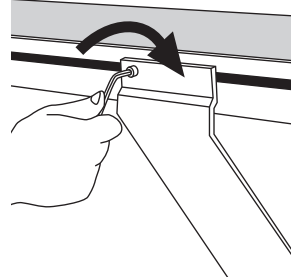

7 Tighten socket head cap screw on frame.

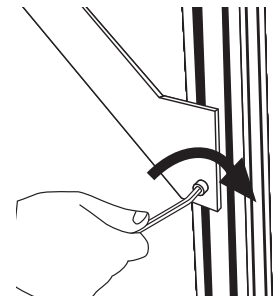

8 Tighten socket head cap screw on stand.

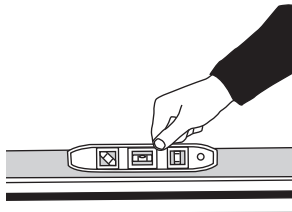

9 Check with bubble level to ensure conveyor is level.

> Repeat for opposite side.

⚠ Injury is possible if the stands are not lagged to the floor, cross ties are not used, or angle braces are not present. Never place a conveyor in operation until all proper mounts are installed and secured.

Warning: Moving conveyors with casters can create dynamic forces that could tip the conveyor. Use caution when moving a conveyor with casters.

Mount Installation

Ensure mount placement on mounting surface allows clearance for drive package.

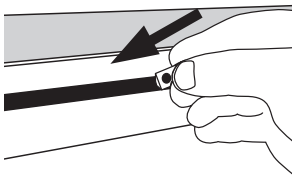

x2

1 Insert drop in nuts into t-slot.

> Proceed to correct mounting type.

► Flush Mount

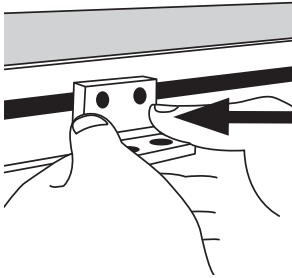

1 Line up mount to drop in nuts.

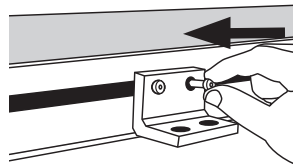

x2

2 Insert socket head cap screws through mount and into drop in nut.

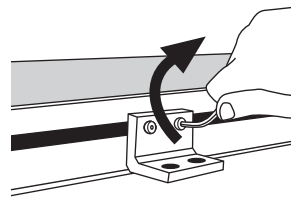

x2

3 Tighten screws to secure mount to frame.

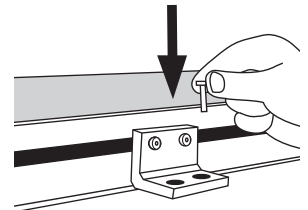

x2

4 Insert screws (not provided) into desired mounting surface and tighten.

► Raised Mount

Mounts' foot can be placed facing inward or outward depending on application.

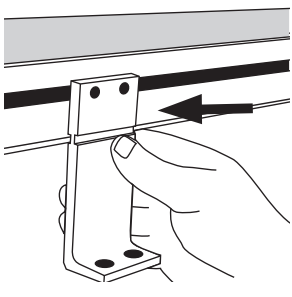

1 Line up mount to drop in nuts.

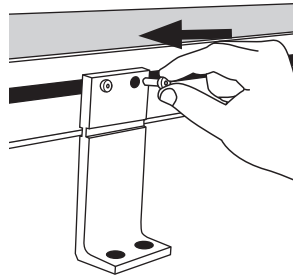

2 Insert socket head cap screws through mount and into drop in nut.

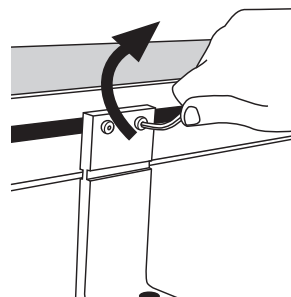

3 Tighten screws to secure mount to frame.

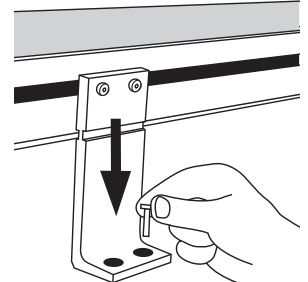

4 Insert screws (not provided) into desired mounting surface and tighten.

Side / Guide Installation

Guide brackets can not be placed over drive assembly mounting brackets.

► Installing Fixed Side Rails

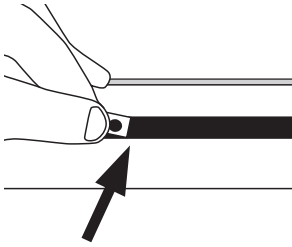

1 Insert drop in nuts into t-slot on frame.

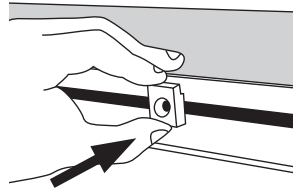

2 Align guide brackets with drop in nuts.

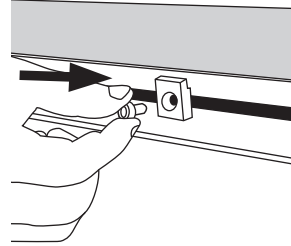

3 Insert socket head cap screw through guide clamp and into drop in nuts.

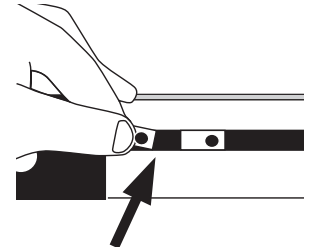

x2

4 insert two drop in nuts into t-slot at tail end of frame.

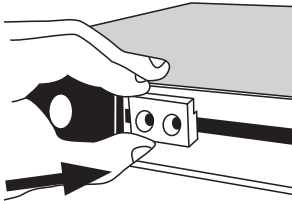

5 Align clamping block to drop in nuts.

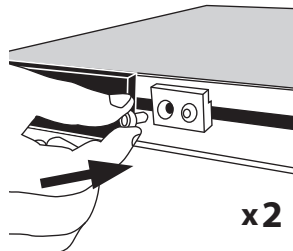

x2

6 Insert screws through clamping block and into drop in nuts.

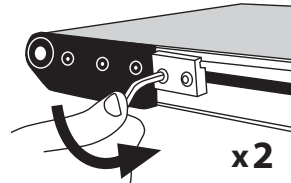

x2

7 Loosen tracking block screws. (Do not remove)

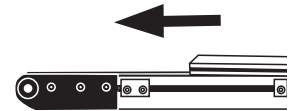

8 Slide guide rail in between clamps and frame until in place.

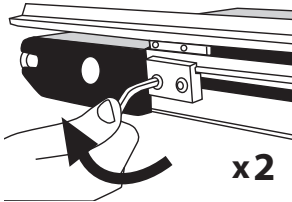

x2

9 Tighten screws in clamping blocks.

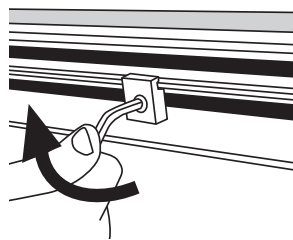

10 Tighten screws in guide clamps.

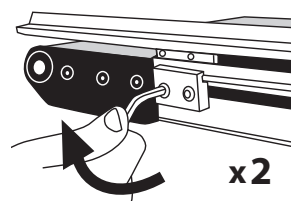

x2

11 Retighten screws in tracking block.

If sides have seals, speed of conveyor should be no faster than 30 feet per minute.

Side seals are designed for use with MAA Standard Urethane Belts.

► **Installing Adjustable Guide Brackets**

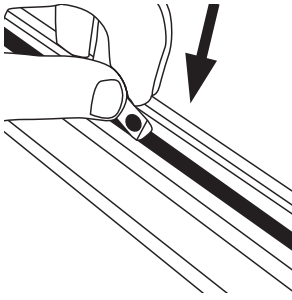

1 Insert economy nuts into t-slot of guiderail and slide into position

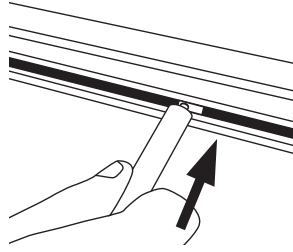

2 Loosely thread adjusting rod into nuts.

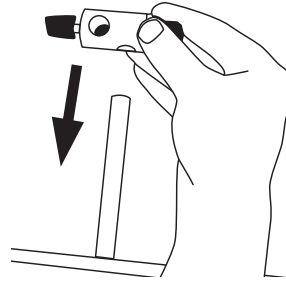

3 Place a cross block onto each guiderail and set aside.

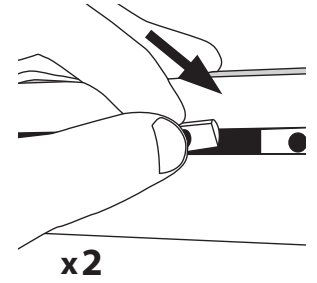

4 Insert drop in nuts into t-slot on frame.
x2

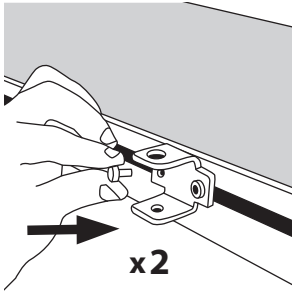

5 Align guide bracket, keeping the larger hole up, with drop in nuts and insert screws.
x2

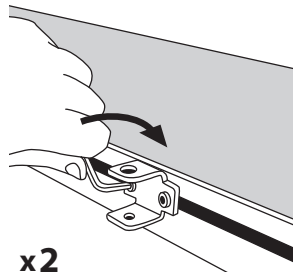

6 Tighten socket head cap screws.
x2

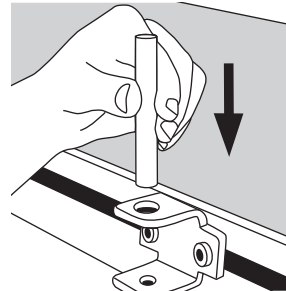

7 Insert a rod vertically through the larger hole on top of guide bracket.

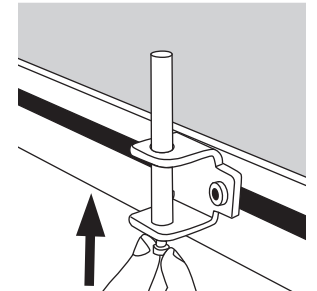

8 Secure rod from below with socket head cap screw.

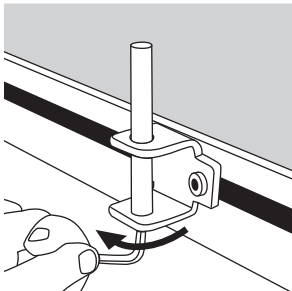

9 Tighten cap screw.

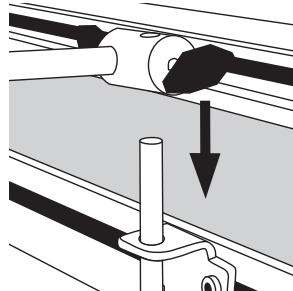

10 Slide guiderail assembly over vertical rods on frame.

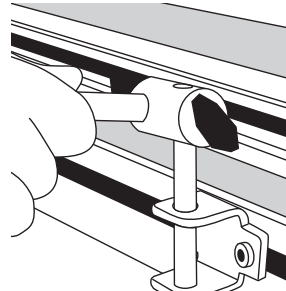

11 Adjust guides to desired width and tighten rods.

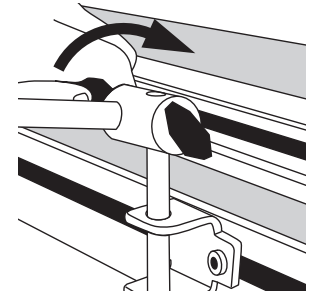

12 Tighten screw on cross block to secure rod.

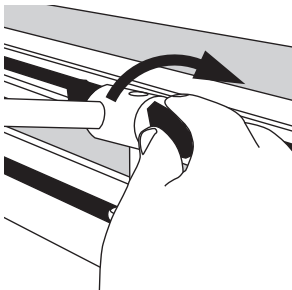

13 Install guiderail and block assembly over vertical rods and adjust to desired height. (Guide should NOT touch belt)

Maintenance

Belt Tracking

> For best results, make adjustments to only one side.

► Belt Tracking at Infeed and Outfeed Pulleys

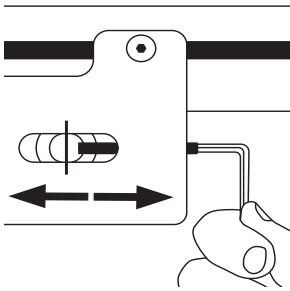

1 Starting at infeed idler pulley, rotate adjustment screw on side where adjustment is needed.

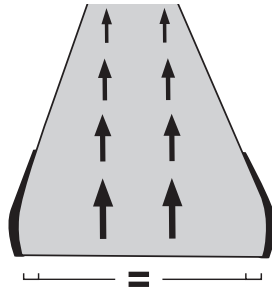

2 Let belt make several rotations to ensure proper tracking. (Proper tracking is achieved when belt can make a full revolution without contacting either side of frame.)

► Belt Tracking at Tail End

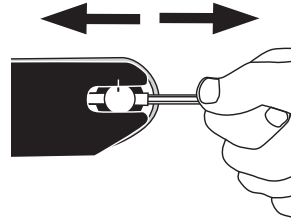

1 Rotate adjustment screw on side where belt is riding too close.

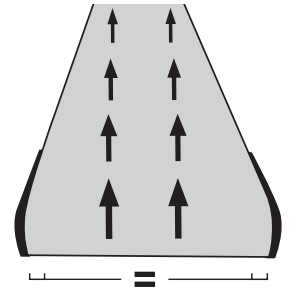

2 Let belt make several rotations to ensure proper tracking. (Proper tracking is achieved when belt can make a full revolution without contacting either side of frame.)

► Belt Tracking at Drive End

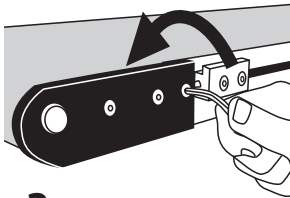

x3

1 Loosen three driver assembly screws on each side of bearing block.

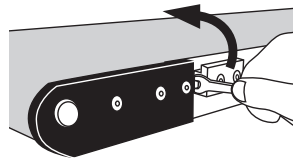

2 With conveyor running, rotate square head tracking screw toward drive pulley on side where belt is riding too close.

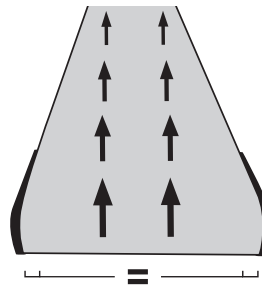

3 Let conveyor make several rotations to ensure belt is tracking properly.

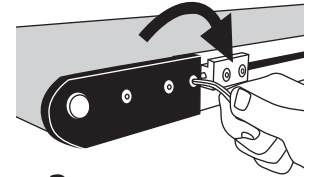

x3

4 Retighten driver assembly screws. (Three on each side)

The Drive End is tracked when the belt can make a full revolution without contacting either bearing plate.

Belt Change

► Removal of Existing Belt

- > Full width idlers must be removed before changing belt.

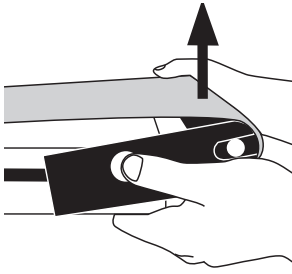

1 Simultaneously push in both buttons on tension release tail to disengage locking mechanism. (Frame end could have sharp edges)

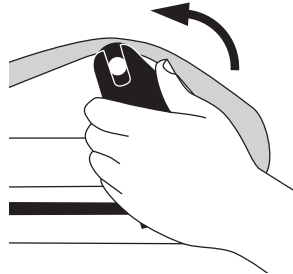

2 Rotate tension release tail assembly up and towards the drive end.

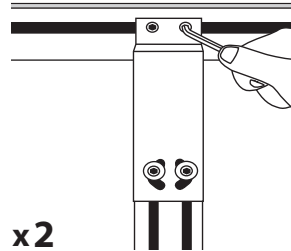

x2
3 Loosen screws on mounts/brackets on opposite side of drive.

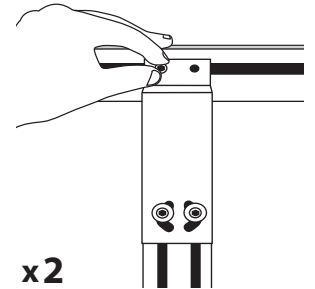

x2
4 Remove screws from stand brackets or mounts. (If stand brackets are not used, proceed to step 7)

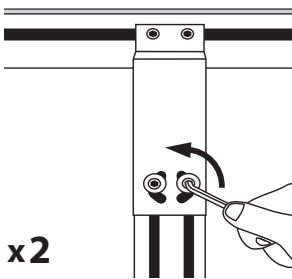

x2
5 Loosen screws on stand. (Do not remove)

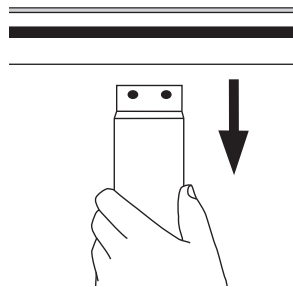

6 Slide stand bracket down for clearance.

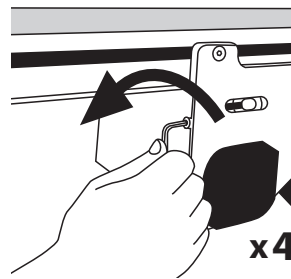

x4
7 Remove four screws holding guard from frame on drive pulley side.

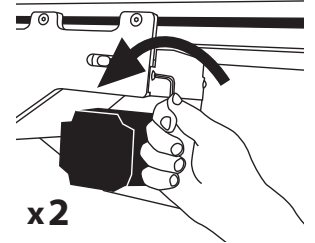

x2
8 Remove two screws holding guard on opposite side above motor.

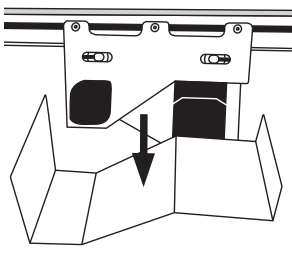

9 Remove guard.

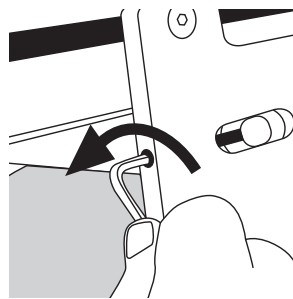

10 Loosen both adjustment screws on drive pulley side to allow clearance for idler pulley removal.

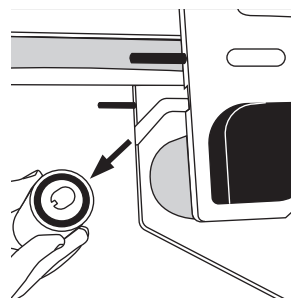

11 Slide idler pulley out of slot and set aside.

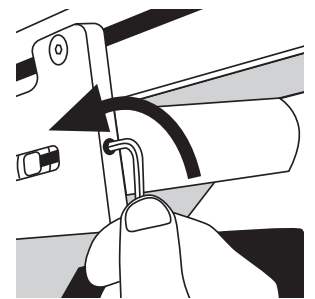

12 Loosen both adjustment screws on motor side to allow clearance for idler pulley removal.

► **Removal of Existing Belt (continued)**

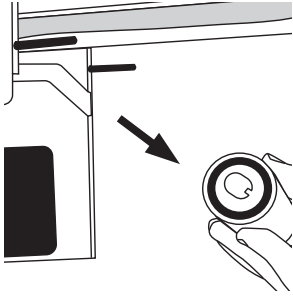

13 Slide idler pulley out of slot and set aside.

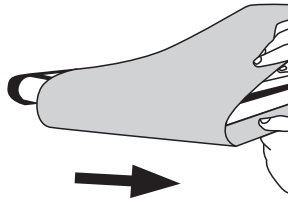

14 Slide belt off idler end of conveyor.

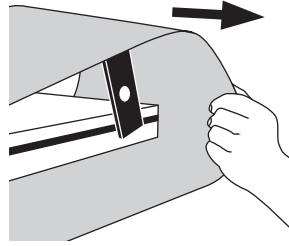

15 Loop belt off of tension release tail end of conveyor.

► **Installation of New Belt**

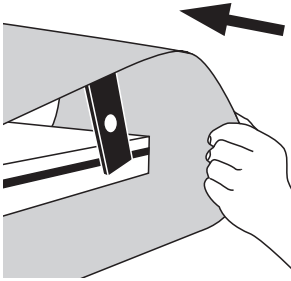

1 Loop belt over tension release tail end.

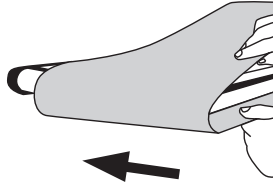

2 Slide belt onto idler end of conveyor.

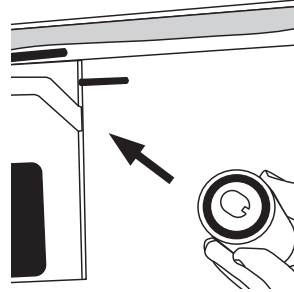

3 Slide idler pulley into slot above motor, pushing the belt up and into position. (Ensure recess in shaft is pointed away from mounting package)

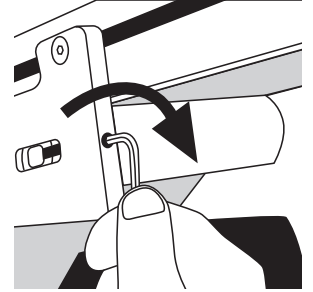

4 Tighten adjustment screws until pulley creates tension on belt and marks are aligned.

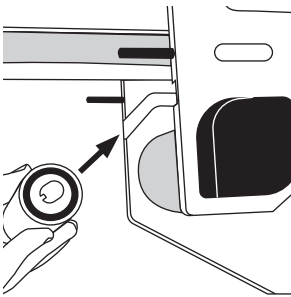

5 Slide other idler pulley into opposite slot above drive pulley, pushing the belt up and into position. (Ensure recess in shaft is pointed away from mounting package)

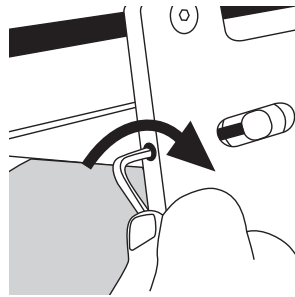

6 Tighten adjustment screws until pulley creates tension on belt and marks are aligned.

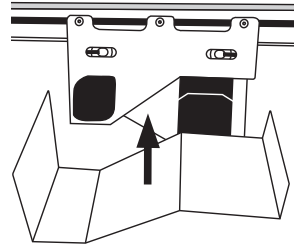

7 Replace guard.

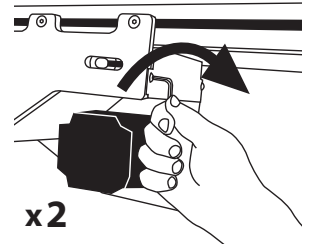

8 Replace and tighten both screws holding guard above motor.

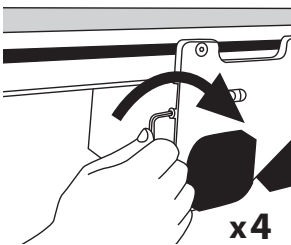

9 Replace and tighten four screws holding guard on opposite side.

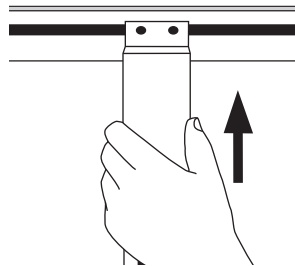

10 Slide mounting brackets into place.

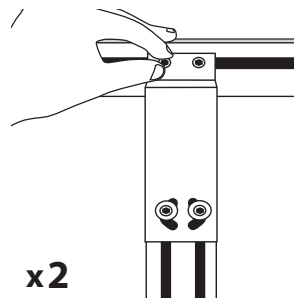

11 Insert screws through bracket and into drop in nuts in frame.

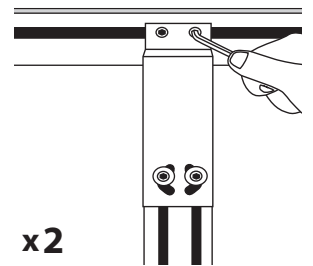

12 Tighten screws holding bracket to conveyor frame.

► Installation of New Belt (continued)

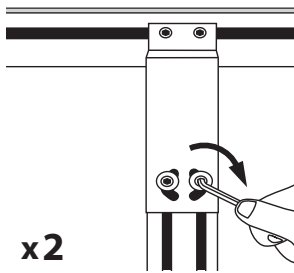

13 Tighten screws holding bracket to stand.

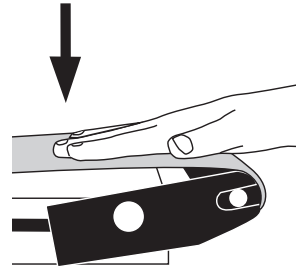

14 Press down on tension release tail until it "locks" into place and creates tension on belt.

- > Re-install any full width idlers that were removed prior to belt change.
- > Belt is now ready to be tracked and tensioned. See proper sections of this manual for instructions.

Motor Positioning

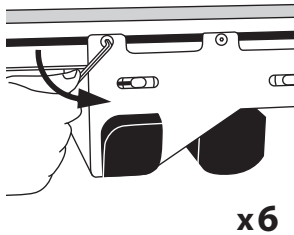

1 Loosen (do not remove) 6 screws (3 per side) on motor mount plates.

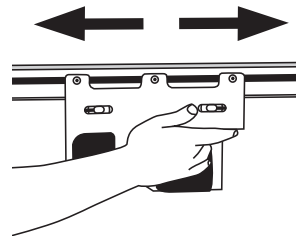

2 Slide center drive assembly into position. (Keep in mind stand placement and underside idler placement)

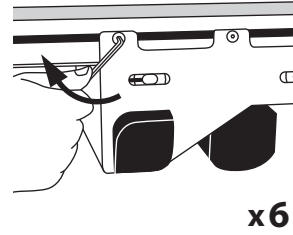

3 Tighten 6 screws (3 per side) on motor mounting plates.

Belt Tensioning

► Belt Tension at Tail End

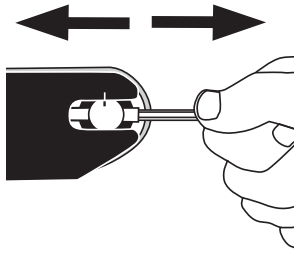

- 1** Adjust the set screws on the tail assembly so the tail pulley assembly moves away from the conveyor frame. (Extend both screws the same amount).

► Belt Tension at Drive Pulleys

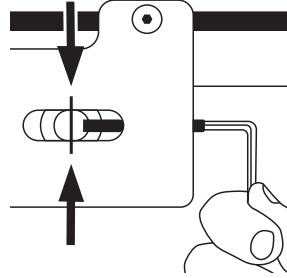

- 1** Ensure marks on pulley are lined up with marks on drive mounting plate. If not proceed to step two.

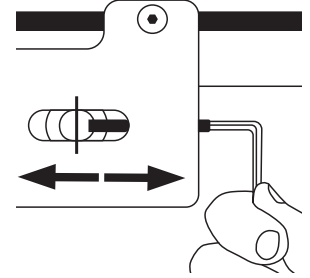

- 2** Rotate set screws at both ends of pulley to align marks on pulley with marks on drive mounting plate.

► Belt Tension at Drive End

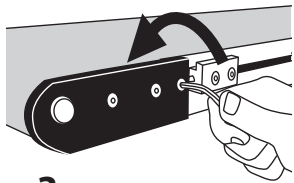

x3

- 1** Loosen six driver assembly screws in bearing blocks about half a turn. (Three on each side)

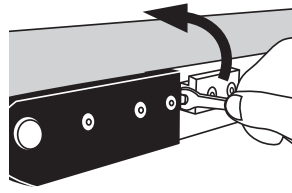

- 2** Extend the square head tracking screws on both sides of the conveyor until desired tension is achieved. (Extend both screws the same amount)

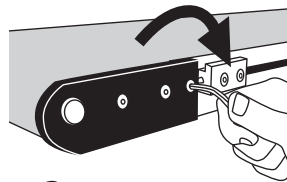

x3

- 3** Retighten six driver assembly screws to lock assembly into position. (Three on each side)

> After tensioning, belt may need to be tracked. Refer to Belt Tracking section of this manual.

If after following these steps, additional belt tension is needed, it is recommended that a new belt be installed.

Care and Cleaning

► Belt Care / Cleaning

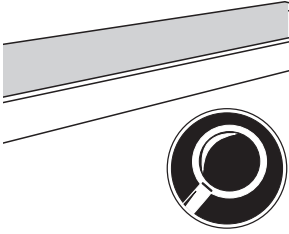

1 Inspect Belt for any fraying or tears and replace if needed.

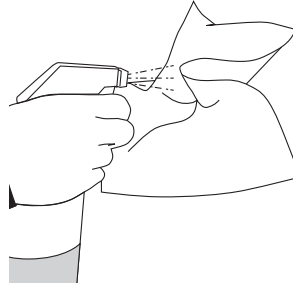

2 Spray cleaning solution on a clean rag.

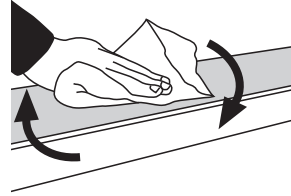

3 Wipe belt with rag.

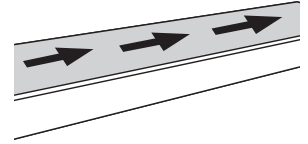

4 Cycle conveyor to reveal opposite side of belt.

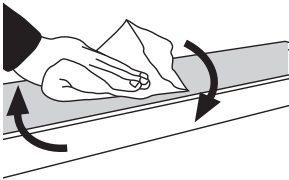

5 Wipe belt with rag.

> For best results, repeat steps until entire belt has been cleaned.

► Tail Pulley Replacement

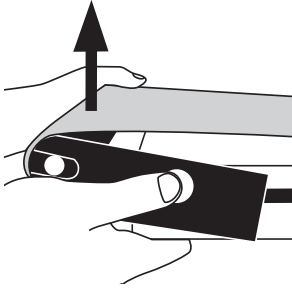

1 Press both tension release buttons and lift up simultaneously.

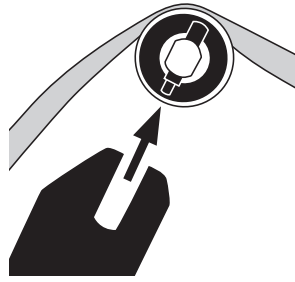

2 Lift idler pulley out of slot.

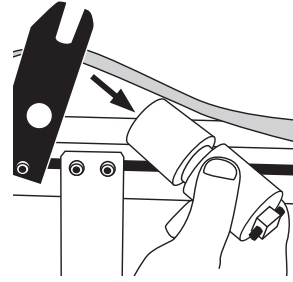

3 Remove idler pulley from conveyor.

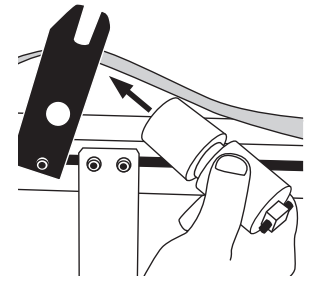

4 Replace with new idler pulley.

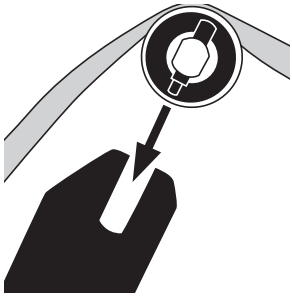

5 Making sure to keep dog point of set screw facing down, insert idler pulley back into slot.

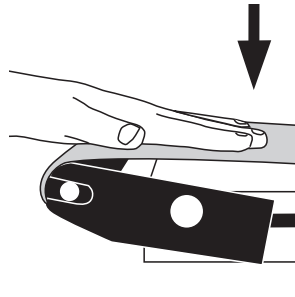

6 Press tail pulley down until it "snaps" into the locked position.

> Re-tensioning and tracking of belt may be necessary. (Refer to tracking and tensioning sections of this manual.)

Recommended Spare Parts

► Parts List

Part #	Description
1A0039B00WW	Tail Pulley Assembly
AC6-WW-LLL-MAE	White Urethane Belt (MVE for V-Guided)
1A0102C	Fixed End Bearing Housing LH
1A0103C	Fixed End Bearing Housing RH
1D0317A	Fixed End Bearing
1D0057A	Center Drive Bearing
1A0033A00WW	Underside Idler Roller 8"- 24" Full Width
1A0036A	Underside Idler 2"- 6" Wide Stub Roller
C-0117-090	Drive Timing Belt (≤ 50 Sprocket teeth)
C-0117-100	Drive Timing Belt (≥ 52 sprocket teeth)
1A0043A00WW	Center Idler Pulley Assembly
1D0048A00WW	Center Drive Pulley

- > Use the two digit width of the conveyor for "WW".
Use the width and 3-digit length of the conveyor for "LLL".
- > To order parts, please visit QCconveyors.com/serial or call us at +1 (513) 753-6000.

Troubleshooting

Symptom	Possible Cause	Corrective Action
Belt is slipping or stops under load	Demand is more than the conveyor is rated for	Verify conveyor capacity
	Lubrication between drive pulley and belt	Clean bottom of belt and drive pulley
	Belt is not tensioned properly	Refer to section on tensioning the belt (page 26)
Belt does not move without load	Timing belt under drive guard is not connected	Contact factory
	Belt is not tensioned properly	Refer to section on tensioning the belt (page 26)
Belt will not track at drive end	Accumulation or belt wear	Refer to Belt Tracking section of this manual (page 23)
	Improper tension	Refer to Belt Tensioning section of this manual (page 26)
Belt will not track at tail end	Irregular product loading or belt wear	Refer to Belt Tracking section of this manual (page 23)
	Improper tension	Refer to Belt Tensioning section of this manual (page 26)
Belt will not track at center idlers		
Belt is brittle, delaminating or is discolored	Belt is being attacked by chemicals or excessive heat	Contact factory to discuss belt application
	Belt life has expired	Replace belt
	Urethane belts can discolor when exposed to UV light	No corrective action
Motor is hot	Motor can run with a skin temperature of 221°F	No corrective action
	Motor is not protected with overload protection and is drawing too much current.	Install overload protection on motor
Speed reducer is getting hot	Speed reducer can run with skin temperature of 225°F	No corrective action
Speed reducer is leaking oil	Speed reducer's life has expired	Replace speed reducer
	Installation was performed incorrectly and input seal was damaged	Replace speed reducer
Bearing noise	Bearings are damaged or failing	Refer to Bearing Replacement section of this manual (page 28)
Belt is traveling reverse of desired direction	Motor or speed reducer not wired properly	Check wiring and correct per wiring instructions
Conveyor belt has prematurely worn out	Correct belt not selected for application	Contact factory to discuss belt application

If you are unable to remedy the problem with these corrective actions, please contact QC Conveyors Customer Service at (513) 753-6000. Failure to correct the problem may lead to abnormal use of the conveyor, thereby voiding the warranty.

Exploded Views / BoM's

► 2"-12" Wide Center Drive Automation Series Conveyor

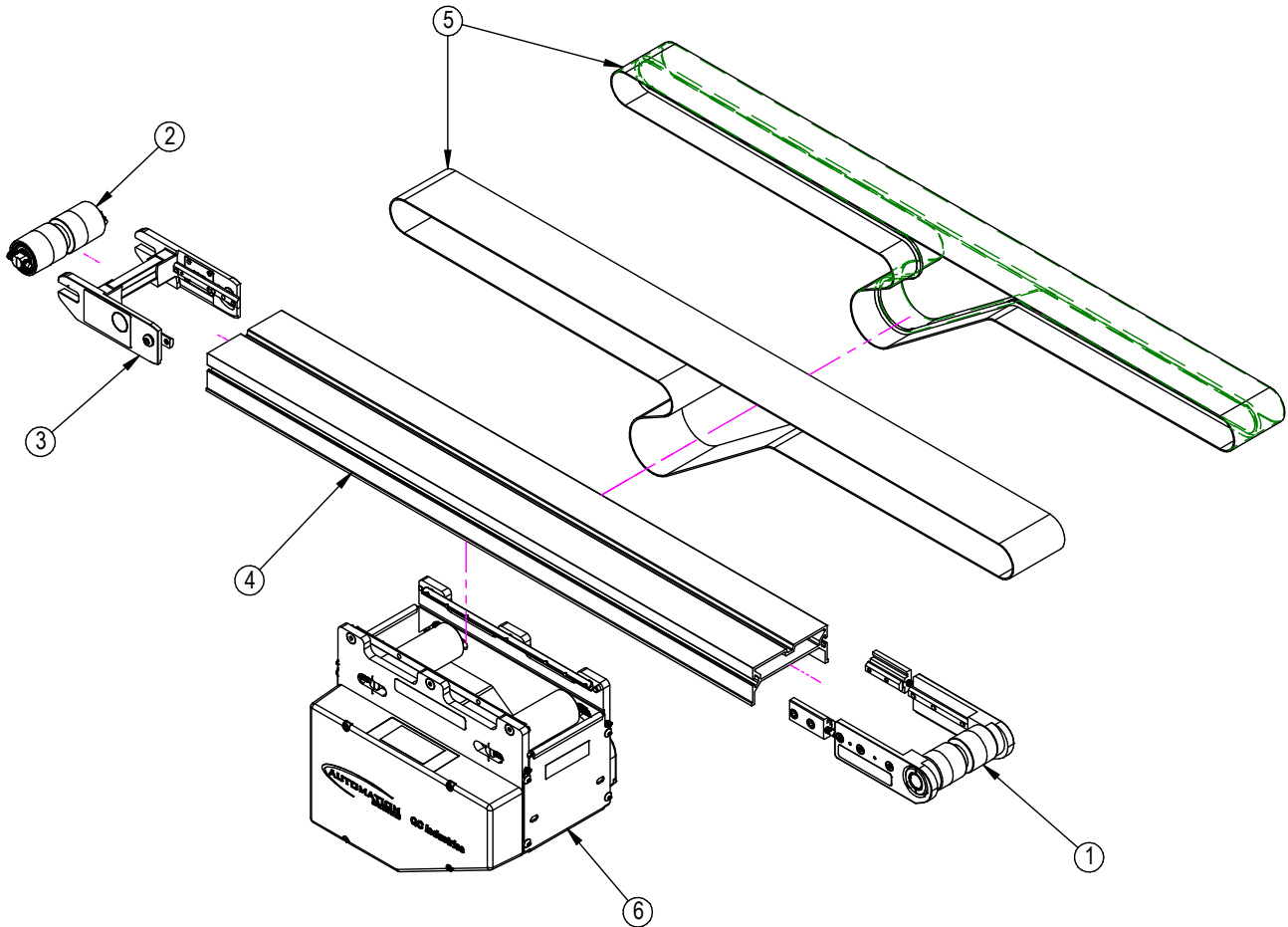

#	Part #	Description
1	1A0044C00WW	ASSY CENTER DRIVE FIXED END IDLER
2	1A0039B00WW	ASSY TAIL V-GUIDED
3	1A0038A00WW	ASSY TENSION RELEASE TAIL
4	1D0012ALLL	SLIDER BED ALUMINUM EXTRUSION 2" WIDE
	1D0013ALLL	SLIDER BED ALUMINUM EXTRUSION 3" WIDE
	1D0014ALLL	SLIDER BED ALUMINUM EXTRUSION 4" WIDE
	1D0015ALLL	SLIDER BED ALUMINUM EXTRUSION 5" WIDE
	1D0016ALLL	SLIDER BED ALUMINUM EXTRUSION 6" WIDE
	1D0017ALLL	SLIDER BED ALUMINUM EXTRUSION 8" WIDE
	1D0060ALLL	SLIDER BED ALUMINUM EXTRUSION 10" WIDE
	1D0061ALLL	SLIDER BED ALUMINUM EXTRUSION 12" WIDE
5	AC6-WW-LLL-MAE	BELT AUTOMATION SERIES CENTER DRIVE STANDARD
	AC6-WW-LLL-MVE	BELT AUTOMATION SERIES CENTER DRIVE V-GUIDED
6	1A0073A00WW	ASSY CENTER DRIVE PACKAGE

► 18"-24" Wide Center Drive Automation Series Conveyor

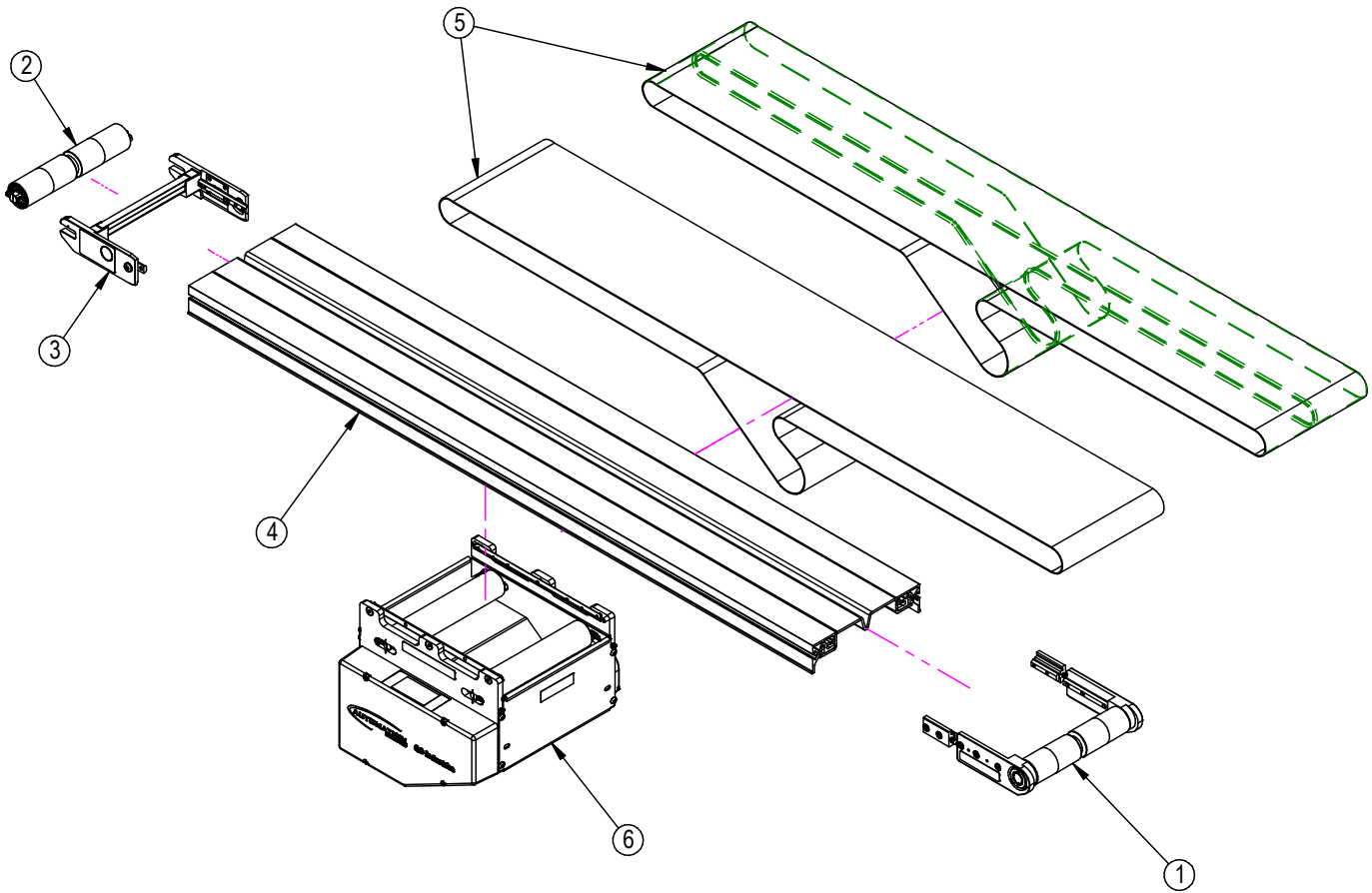

#	Part #	Description
1	1A0044B00WW	ASSY CENTER DRIVE FIXED END IDLER
2	1A0039A00WW	ASSY TAIL V-GUIDED
3	1A0038A00WW	ASSY TENSION RELEASE TAIL
4	1A0071A-WW-LLL	ASSY MULTI-PIECE FRAME
5	AC6-WW-LLL-MAE	BELT AUTOMATION SERIES CENTER DRIVE STANDARD
	AC6-WW-LLL-MVE	BELT AUTOMATION SERIES CENTER DRIVE V-GUIDED
6	1A0073A00WW	ASSY CENTER DRIVE PACKAGE

► Automation Series Center Drive Package Assembly

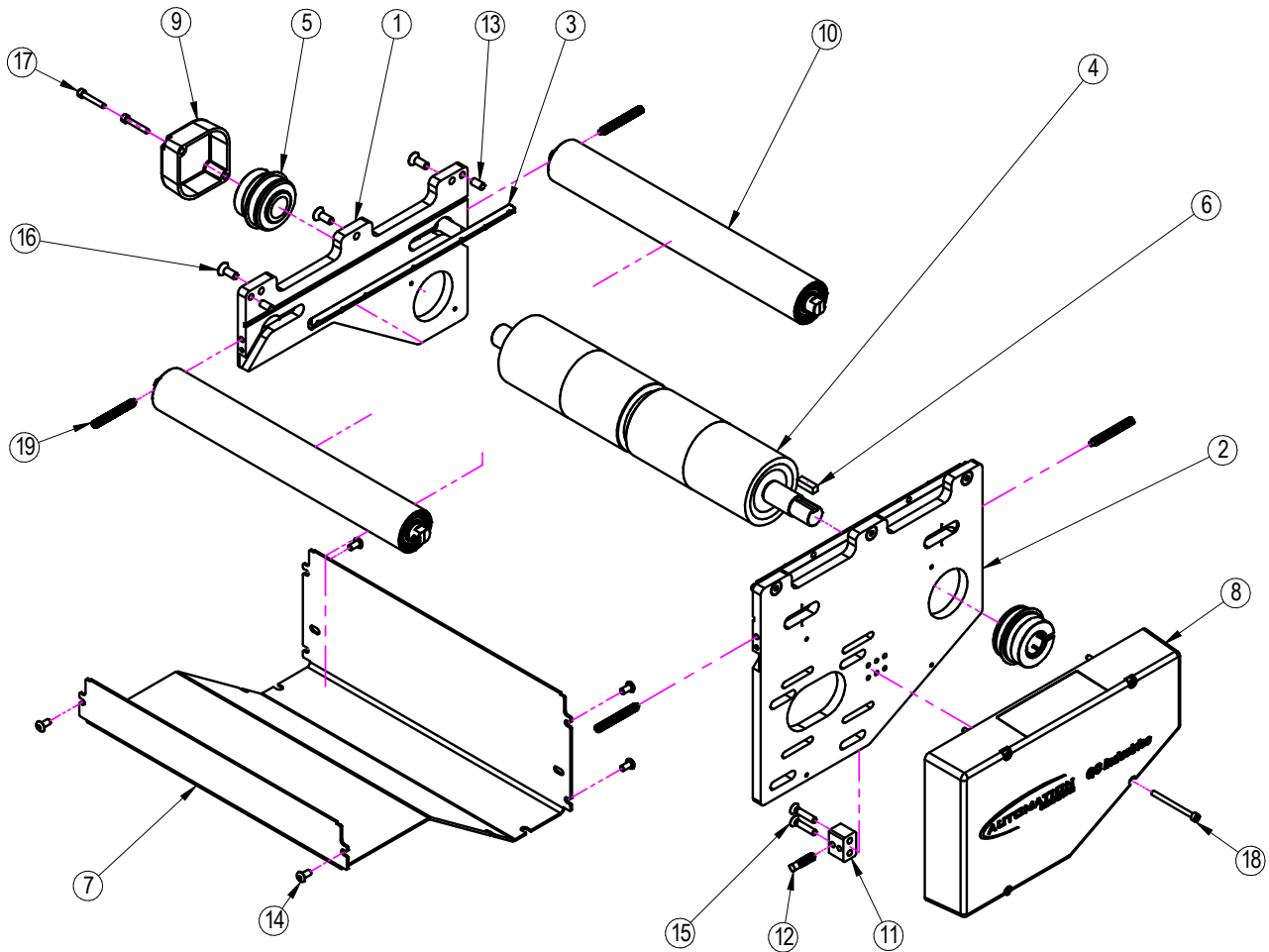

#	Part #	Description
1	1D0035A	PLATE, CENTER DRIVE, NON-DRIVE SIDE
2	1D0051A	PLATE, CENTER DRIVE, MOTOR MOUNTING
3	1D0031A	ANCHOR BAR, CENTER DRIVE MTG
4	1D0048AWWWW	PULLEY, CENTER DRIVE
5	1D0057A	BEARING, CENTER DRIVE, SQUEEZE LOCK STYLE
6	1D0130A	KEY, 6mm SQUARE x 19mm LG.
7	1D0049AWWWW	GUARD, CENTER DRIVE CONV. BELT
8	1D0050A	DRIVE COVER, CENTER DRIVE CONVEYOR
9	1D0052A	COVER, BEARING, CENTER DRIVE, NON DRIVE SIDE
10	1A0043AWWWW	ASSY CENTER DRIVE IDLER
11	1D0109A	BLOCK, JACKING
12	1D0116A	SCREW SQUARE HEAD M6 X 20 MM LG
13	1D0170A	PIN, DOWEL, HARDENED, 6 OD X 12 LG
14	BHCS-M05X080X010-ZP	SCREW BUTTON HEAD CAP M5 X 0.8 X 10 LG ZP
17	SHCS M04X070X025-ZP	SCREW SOCKET HEAD CAP M4 X 0.7 X 25mm ZP
18	SHCS M04X070X050-ZP	SCREW SOCKET HEAD CAP M4 X .7 X 50mm ZP
19	SHSS-M08X125X050-BX-B	SCREW SOCKET HEAD SET

► Automation Series Center Drive Idler Pulley Assembly

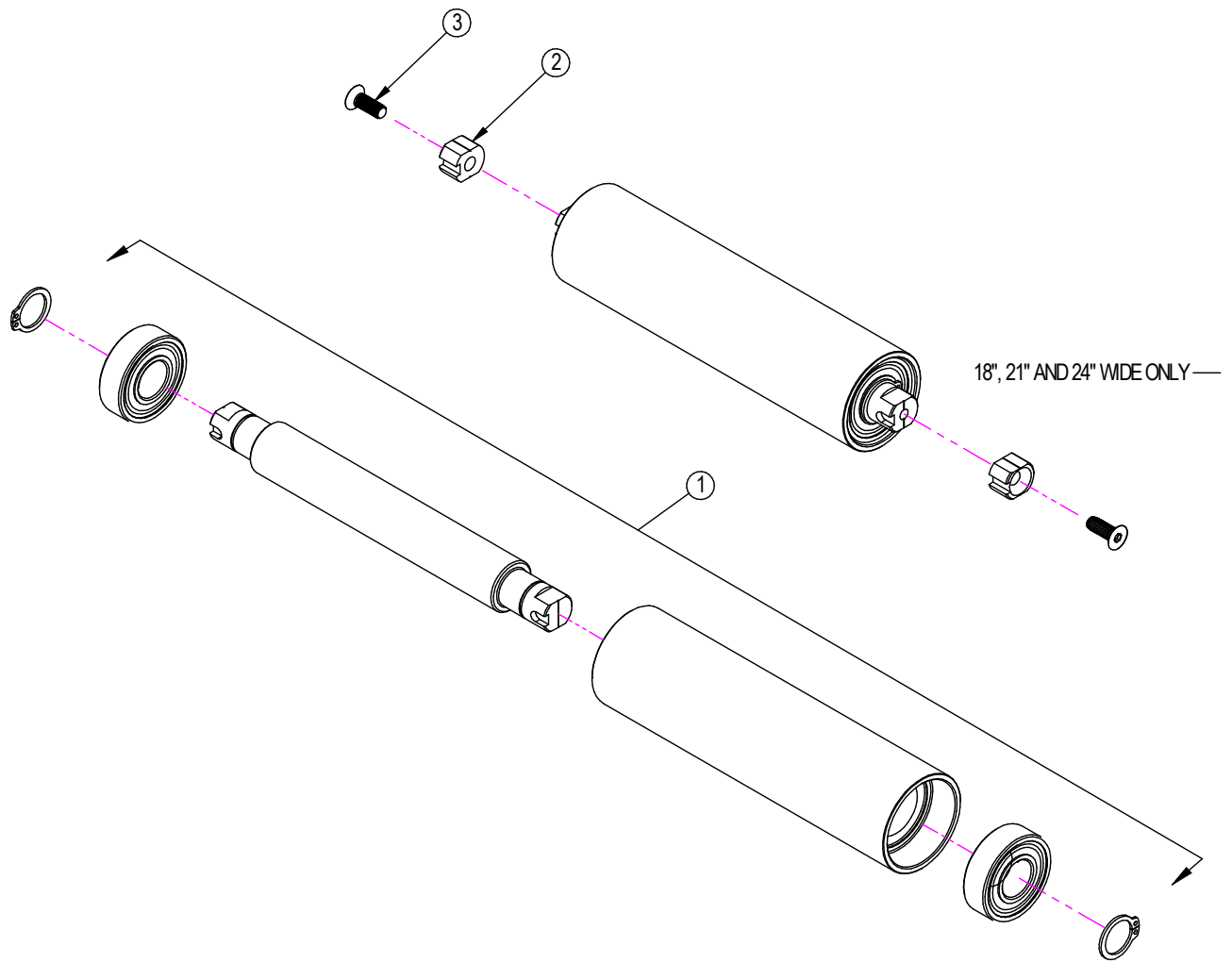

#	Part #	Description
1	1A0043A	AS40-CD IDLER PULLEY ASSEMBLY WITH BEARINGS
2	1D0304A	SHAFT EXTENSION CENTER DRIVE IDLER
3	FHCS-M05X080X014-ZP	SCREW FLAT HEAD CAP M5 X 0.8 X 14 LG. ZP

► Automation Series Center Drive Fixed End Idler Assembly

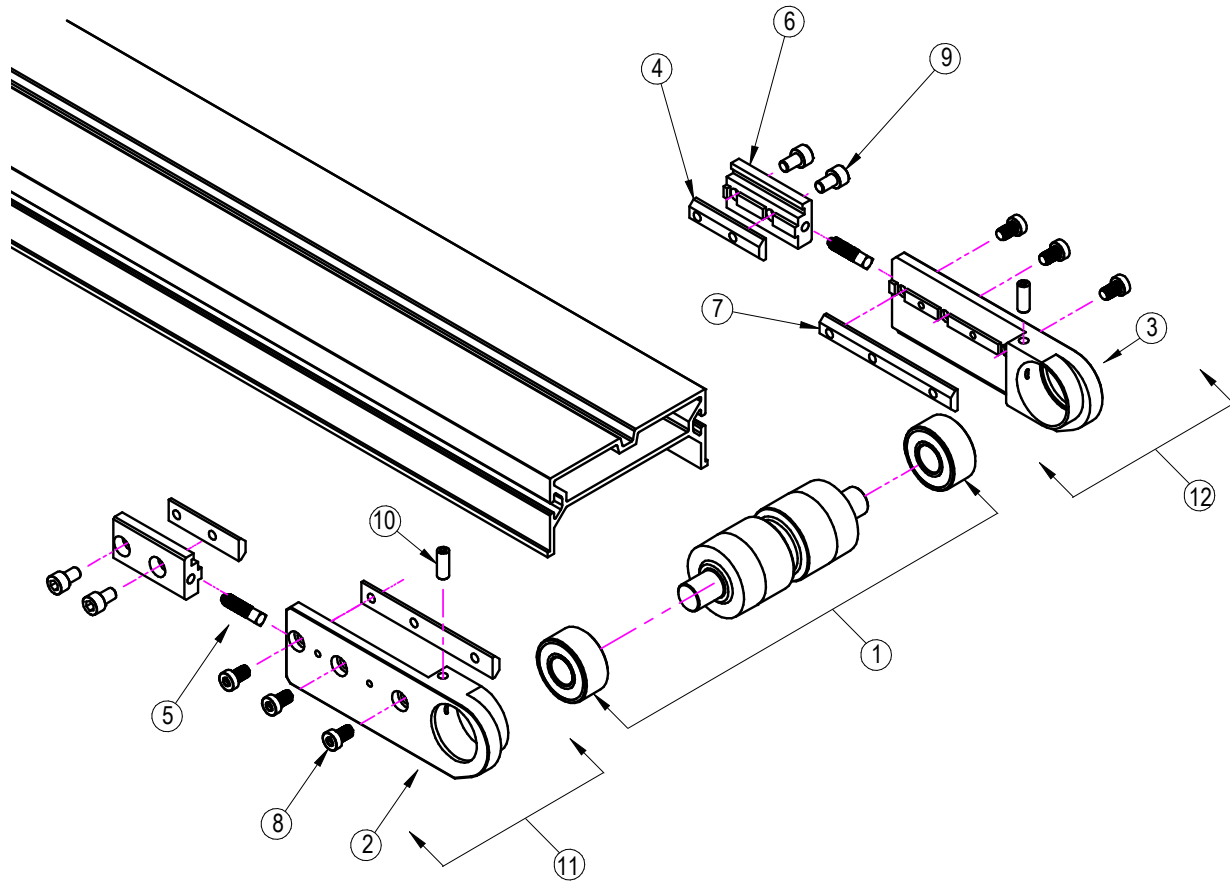

#	Part #	Description
	1D0034C00WW	PULLEY CENTER DRIVE FIXED END IDLER
1	1A0101C	AS40-CD FIXED END DRIVE PULLEY WITH BEARINGS
2	1A0102A	DRIVE BEARING HOUSING LH
3	1A0103A	DRIVE BEARING HOUSING RH
4	1D0124A	ANCHOR BAR JACKING BLOCK
5	1D0116A	SCREW JACKING SQ. HEAD M6x1.0 20MM LG.
6	1D0126A	BLOCK JACKING RH DRIVE END
7	1D0080A	ANCHOR BAR BEARING HOUSING
8	SLHCS-M6X100X010-BX	SCREW SOCKET LOW HEAD CAP M6x1.0 10MM LG.
9	SHCS-M06X100X010-ZP	SCREW SOCKET HEAD CAP M6x1.0 10MM LG.
10	SHSS-M06X100X016-ZP	SCREW SOCKET HEAD M6x1.0 16MM LG.
11	1A0034C	ASSY BEARING PLATE WITH BEARING LH
12	1A0035C	ASSY BEARING PLATE WITH BEARING RH

► Automation Series Tension Release Tail Assembly

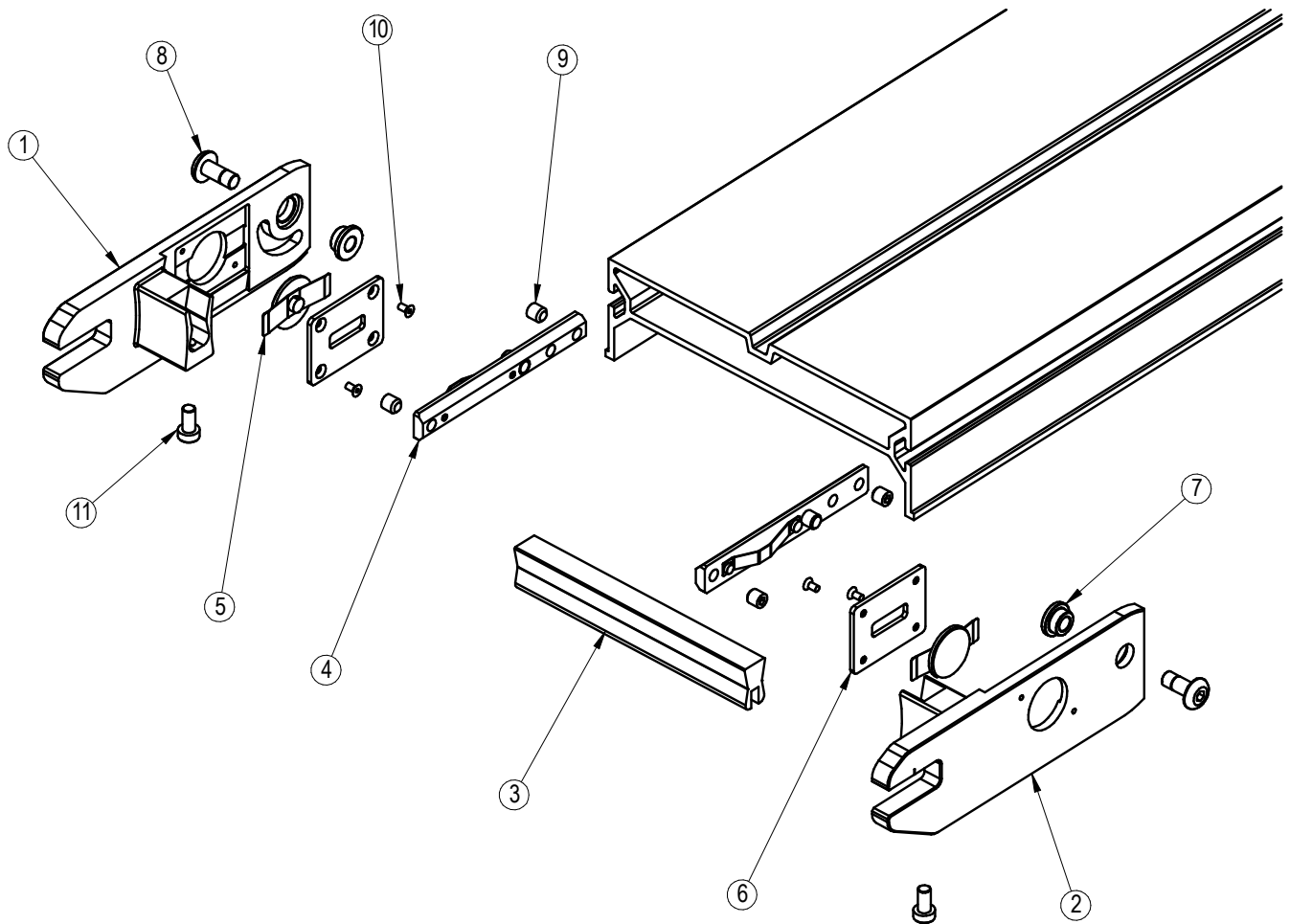

#	Part #	Description
	1A0038A00WW	TENSION RELEASE TAIL ASSEMBLY
1	1D0181A	INDIVIDUAL TAIL PLATE RH
2	1D0182A	INDIVIDUAL TAIL PLATE LH
3	1D0172A00WW	TAIL STIFFENER
4	1A0072A	ASSY ANCHOR BAR/TIE SPRING/DOWEL PIN
5	1D0164A	TAIL BUTTON
6	1D0165A	BUTTON RETAINING PLATE
7	1D0168A	BUSHING
8	1D0225A	BUTTON HEAD SHOULDER SCREW
9	SHSS-M06X100X006-ZP	SCREW SOCKET HEAD SET M6x1.0 6mm LG.
10	FHCS-M02.5X045X005-BX	SCREW SOCKET FLAT HEAD M2.5x0.45 5mm LG.
11	SLHCS-M05X080X010-ZP	SCREWS SOCKET LOW HEAD CAP M5x0.8 10mm LG.
12	WSHF-M06X12X16-ZP	WASHER FLAT M6

► Automation Series Tail Pulley Assembly

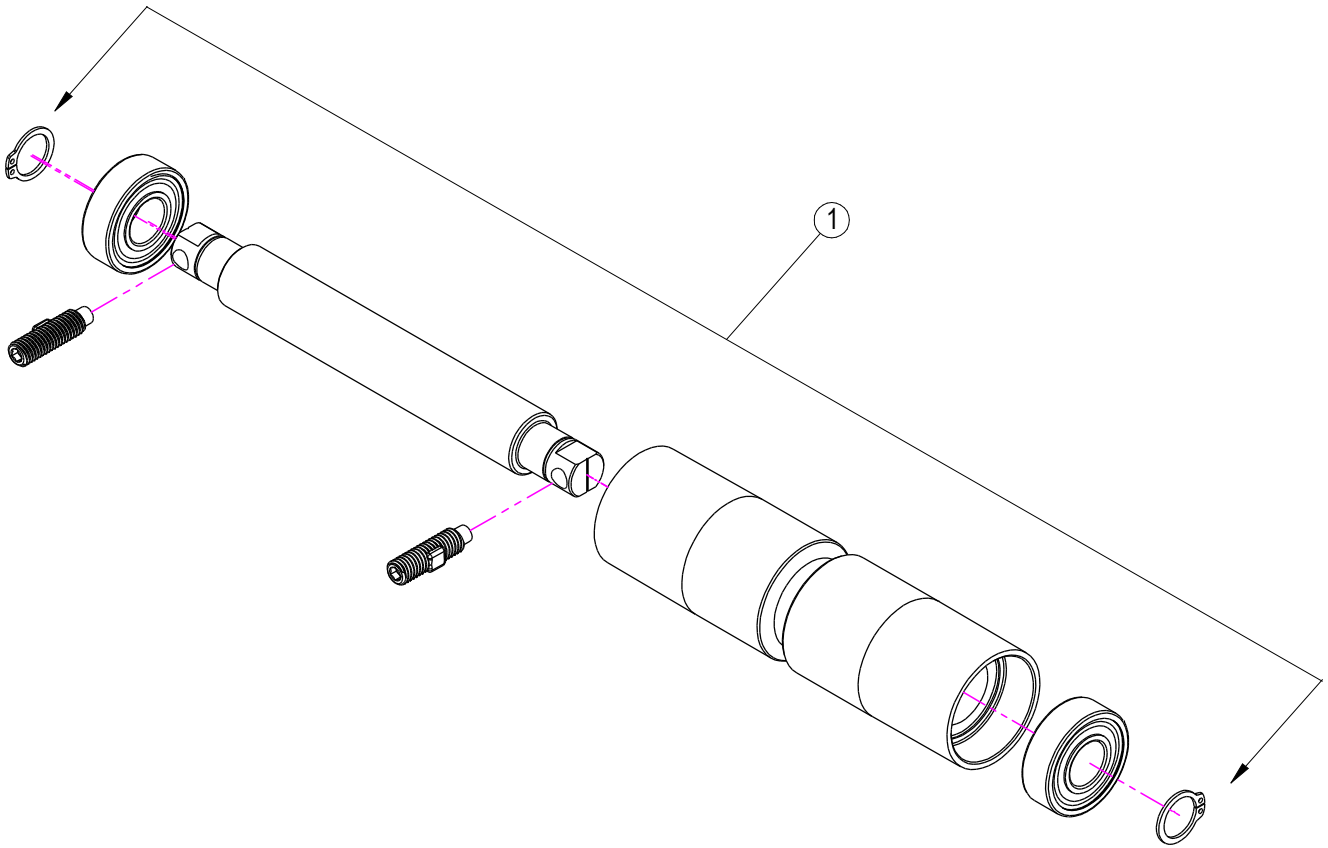

#	Part #	Description
1	1A0039B00WW	AS40 TAIL ASSEMBLY WITH BEARINGS

► Automation Series 2"-6" Wide Stub Underside Idler Assembly

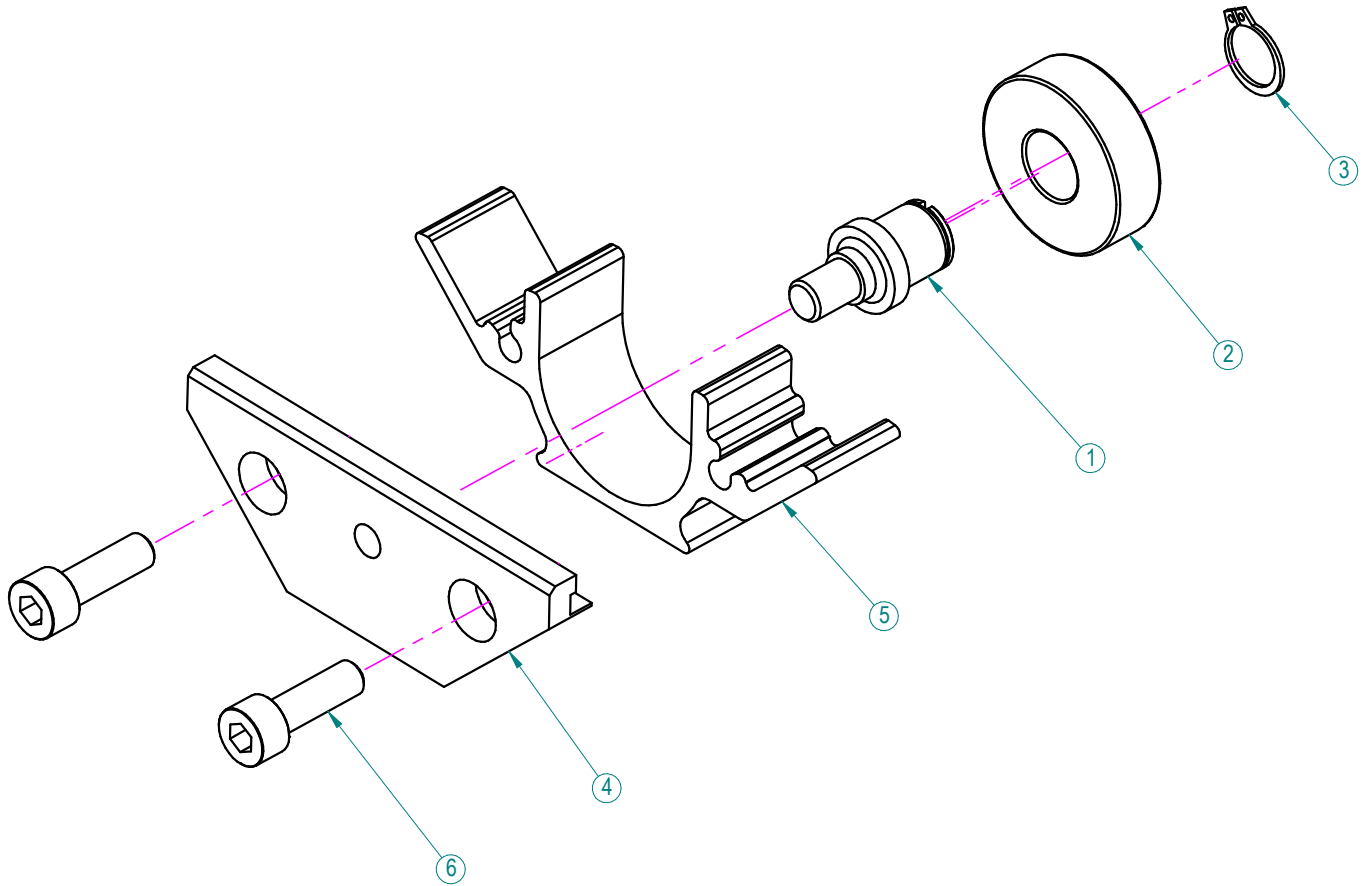

#	Part #	Description
1	1D0152A	SHAFT STUB UNDERSIDE IDLER 2"-6"
2	43-0050-51	BEARING UNDERSIDE IDLER STUB
3	43-0050-52	RETAINING RING
4	1D0151A	CLAMP UNDERSIDE IDLER STUB
5	1D0148A	GUARD UNDERSIDE IDLER STUB 2"-6"
6	SHCS-M05X080X016-ZP	SCREW SOCKET HEAD CAP M5x0.8 16mm LG.

► Automation Series 8"-24" Wide Full Width Underside Idler Assembly

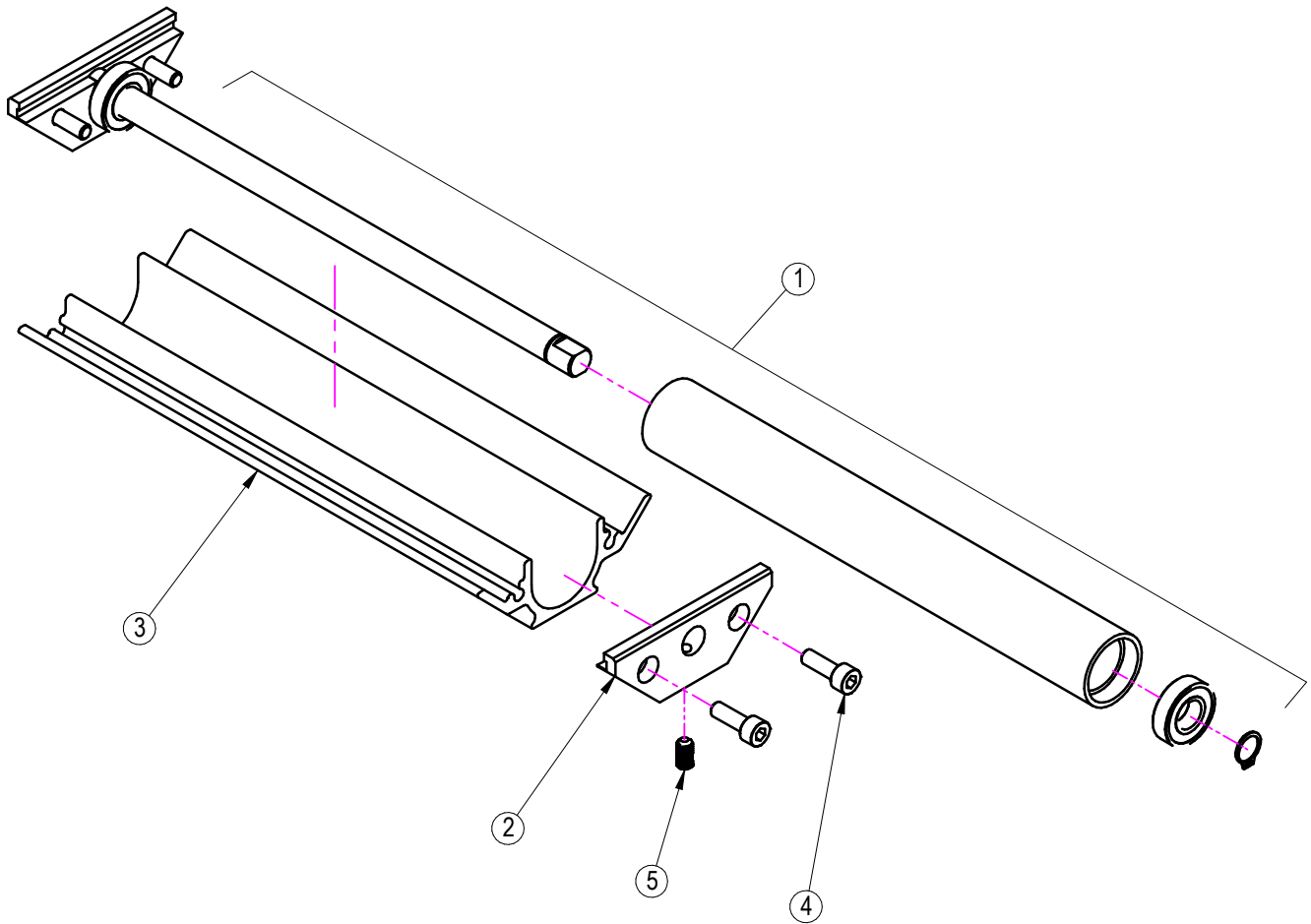

#	Part #	Description
1	1A0042A	AS FULL WIDTH UNDERSIDE IDLER ASSEMBLY (NON-CLEATED BELT)
2	1D0208A	CLAMP UNDERSIDE IDLER FULL WIDTH
3	1D0155A00WW	GUARD UNDERSIDE IDLER FULL WIDTH
4	SHCS-M05X080X016-ZP	SCREW SOCKET HEAD CAP M5x0.8 16mm LG.
5	SHCS-M05X080X10-BX	SCREW SOCKET HEAD SET M5x0.8 10mm LG.

QC Conveyors warrants that our conveyors are free from defects in materials and workmanship and fit for the ordinary purposes for which such goods are used, under normal installation, use and service for ten (10) years* from date of purchase or 21,000 hours* of running use, whichever is sooner. QC Conveyors will replace any defective part within the warranty period, without charge, provided:

- » The Purchaser gives QC Conveyors prompt written notice of the defect, including the date of purchase and original purchase order number.
- » The Purchaser will then be given a return goods authorization number (RGA#) which must be displayed on all labels and packing slips returned with merchandise. (See Return Policy section)
- » The Purchaser pays for delivery of the defective part to QC Conveyors for inspection and verification of the defect.
- » The Purchaser shall pay any costs of installing the replacement part.

This warranty is limited to the replacement of defective parts. **QC Conveyors WILL NOT BE LIABLE FOR ANY DAMAGES CAUSED BY ANY DEFECT IN THIS UNIT.** This warranty shall not apply if any failure of this unit or its parts is caused by unreasonable use, lack of maintenance, improper maintenance and/or repairs, incorrect adjustments, exposure to corrosive or abrasive material, damage causing moisture, or any modification or alteration affecting the operation of the unit which is not authorized by QC Conveyors in writing. This warranty shall not apply to the following items that are covered by their manufacturer's warranty, subject to any limitation contained in those warranties.

- » Bearings
- » Motors
- » Reducers
- » Controllers
- » Casters
- » Belts (Unless otherwise agreed to in writing)

CAUTION: Any attempt to repair such items may actually void the manufacturer's warranty. Any description of this unit is only to identify it and is not a warranty that the unit fits the description. Any warranties implied by law are limited in duration to the ten (10) year term of this warranty. EXCEPT AS SET FORTH HEREIN, QC Conveyors MAKES NO OTHER WARRANTIES, WHETHER EXPRESS, IMPLIED, OR STATUTORY, INCLUDING MERCHANTABILITY FOR FITNESS OR ANY PARTICULAR PURPOSE.

*Warranty is five years/10,500 hours without registration at qcconveyors.com/serial.

Lost or Damaged Goods ◀

Shipments should be inspected immediately upon receipt for lost or damaged goods. Any loss or damage should be noted on the carriers receipt (or bill of lading) at the time of acceptance. If items are perceived to be lost or damaged after the shipment has been accepted, it becomes more difficult to file a claim with the carrier if the receipt does not indicate such loss or damage. Do not, at any time, request the carrier to return any items or shipment to QC Conveyors without previous authorization from our company for such a return. Please notify QC Conveyors as soon as any loss or damage is discovered and request the department that handles the lost or damaged goods. You will need to know a complete description of all lost or damaged items. If replacement items are needed, a purchase order made out to QC Conveyors will need to be supplied. QC Conveyors will then contact the carrier's local agent and request that an inspection of the items be performed. This is absolutely necessary. Unless an inspection is performed, the carrier will not entertain any claim for loss or damage. After the inspection has been completed, the carrier will notify QC Conveyors. If the carrier takes responsibility for the claim, a credit will be issued to you for the replacement item(s), including freight charges from QC Conveyors, where applicable. If the carrier does not take responsibility for the claim, a representative of QC Conveyors will contact you.

Limited Restocking Policy – Products Available for Limited Restocking ◀

We take great pride in our intentionally engineered conveyor systems built for use by you and your customers. Please review the below chart of products available for limited restocking and then review the appropriate policy that applies to the issue at hand.

Product Line	Restock Fee/Cancellation Charge
Automation Series: AS40, AS40-CD, AS40-Z, CB80 Conveyor Systems/Parts	25% Restock Fee/Cancellation Charge
Industrial Series: IS125, IS125-FT, IS175-ID, IS300, IS400 Conveyor Systems/Parts	25% Restock Fee/Cancellation Charge
HydroClean Series: HC200 Conveyor Systems/Parts	30% Restock Fee/Cancellation Charge
Flextrac Series: Alpine, Modular Plastic Chain, Gripper Elevator (Wedge) Conveyor Systems/Parts	50% Restock Fee/Cancellation Charge
Custom OEM Product Lines	25% Restock Fee/Cancellation Charge
PF Series	20% Restock Fee/Cancellation Charge
Custom Engineered/Special Conveyors, Belts or Parts; Discontinued Product Lines	Non-Returnable

If it becomes necessary to cancel or revise an order prior to the order being shipped, QC Conveyors reserves the right to evaluate each order independently prior to authorizing cancellation/revision; restocking / cancellation fees may apply. A restocking charge will be invoiced if an order has been assembled prior to its cancellation or revision. We will not restock custom components (items that are not stocked at QC Conveyors) and those items will be invoiced to the purchaser at list price. If the order contains other-than-stock items, an evaluation will be made based on the status of the order. Additional charges may be included in addition to the restocking fee, if any of the following conditions are met:

- (1) The order contains any items that are considered to be non-stock items and these items have already been produced or are in process by QC Conveyors or one of its suppliers.
- (2) The order contains any items that require special handling or assembly and these processes have been completed.

▷ Limited Restocking Policy

Restocking must meet the following criteria prior to an RGA (Restock Goods Authorization) number being issued:

- (1) Items must be eligible for restock.
- (2) Items must have been purchased within 60 Days (based on invoice date).
- (3) Items must be unopened, undamaged and in resalable condition.

▷ RGA Process – Restocking Goods Authorization

Contact QC Conveyors — Email customerservice@qcconveyors.com or call Customer Service at 513-753-6000

Information Needed for RGA

- (1) Name of Purchaser (Company QC Conveyors invoiced, may be the distributor, if applicable)
- (2) Name of the Customer and/or end user of the item(s).
- (3) Invoice Number - Include any/all purchase order numbers related to the item(s) in question.
- (4) Contact Information - Phone numbers and names of contacts involved.
- (5) Item Number(s) & Quantities - Complete part numbers /quantities of all items involved in the RGA.
- (6) Reason - Complete description as to the reason for the return and the actions that need to be taken.
If the item is to be replaced, a new purchase order number must be supplied by the Purchaser along with complete shipping and billing instructions. These replacements will be treated as separate orders by QC Conveyors and evaluated for possible credit only after returned items are received and evaluated.

Process Once RGA is Approved

- (1) **QC Conveyors Will Email RGA Number** — Once all the above information is provided, we will begin processing your RGA. Once authorization has been approved, you will be emailed the RGA number to use when returning the item(s). RGA numbers will not be given verbally over the phone.
- (2) **Items Must Be Received 30 Days from RGA Issue Date** — Upon receipt of your RGA number, you are required to return the item(s) within 30 days of receipt of RGA number email. After 30 days, the Return Authorization will be void if item(s) are not received by QC Conveyors. All shipping charges and freight insurance charges of restocked goods will be the responsibility of the Purchaser.
- (3) **Returned Items Must Have RGA Number Listed on Packaging** — The RGA number must be clearly marked on the outside of all packages and noted on any paperwork, packing slips, or delivery receipts. If there is no RGA number visible on the package, the package may be refused and sent back at the Purchaser's expense. Parts received in damaged condition due to inadequate packaging are not eligible for credit or warranty consideration.
- (4) **QC Conveyors Will Evaluate RGA and Credit If Applicable** — After receipt of returned goods, QC Conveyors will evaluate the item(s) for credit and take the appropriate action. Items outside of Warranty Issues must be on the Limited Restocking List, must be returned in new, undamaged, resalable condition and must be received within 30 days of RGA Number being assigned. Credit will be issued to the purchaser less restocking fee and any additional fees (evaluation, disassembly, cleaning, disposal, and reissuing of components into inventory). Please allow 30 days for credits to be issued. Full purchase credit will only be issued for defective or damaged initial shipping issues.

»» qcconveyors.com/serial

Manuals, Videos, Replacement Parts

» Register today to double your warranty to 10 Years

QC Industries conveyors come standard with a 5 Year manufacturer's warranty, but if you register online we'll double that to 10 Years, giving you the longest warranty in the conveyor industry.



Register today at qcconveyors.com/serial!

While You're There, You'll Have Access to

- » All the installation and maintenance manuals for your product
- » Product-specific videos to guide you through routine maintenance tasks
- » A complete list of replacement parts along with the original bill of materials and exploded views to help you find exactly the right part
- » Easy replacement part quoting



Registration also entitles you to all the benefits of our Conveyor Configurator, where you can configure and quote conveyor systems with help from our engineering-based configuration tools to ensure your conveyor and components will work together perfectly in your application.

