

# FLEXTRAC SERIES MANUAL

Installation & Maintenance



## CONTENTS

Introduction	page 2
Tools & Fasteners	page 3
Assembly	page 4
Plastic Belt Installation	page 17
Start up & Testing	page 18
Introduction to Maintenance	page 20
Conveyor Chains	page 26

Model Number \_\_\_\_\_

Serial Number \_\_\_\_\_

Date of Install \_\_\_\_\_

*For ease of reference please fill out your conveyor's specific information above*

4057 Clough Woods Drive  
Batavia, OH 45103 USA

+1 (513) 753-6000  
qcconveyors.com



MAN-FT-2002

The purpose of this manual is to help the end user to assemble a Flextrac Series conveyor system. Every chapter includes detailed instructions and photos showing how to assemble each component. Most photos in this manual include parts from MM3 conveyor system, but all instructions are applicable to MS2, ML2, and MX2 conveyor system unless otherwise specified or noted.

### ***Assembly Planning***

- ☑ Fully understand the assembly drawing.
- ☑ Ensure the necessary tools are available.
- ☑ Ensure all the parts and materials included on parts list are available.
- ☑ Ensure necessary space for conveyor installation is available.
- ☑ Ensure the floor is even so the feet can be properly attached to the floor.

### ***Assembly Checklist***

- ☑ Cut all beams to desired length.
- ☑ Connect all feet and structural beams.
- ☑ Mount conveyor beam support brackets.
- ☑ Mount slide rail onto the conveyor beam.
- ☑ Assemble conveyor beams and mount them onto the support structure.
- ☑ Mount drive and idler unit at the end of the conveyor.
- ☑ Check for obstruction of the conveyor with a short piece of chain.
- ☑ Assemble and mount necessary chain onto the conveyor.
- ☑ Mount guide rail and other accessories onto the conveyor.
- ☑ Read the final preparations at the end of this manual.

To assemble a Flextrac Series conveyor, you may need tools listed below.

**Hand Tools**

- ☑ Wrench
- ☑ Slide rail cutter
- ☑ Set of metric Allen wrenches
- ☑ Counter sunk bit
- ☑ Measuring tape
- ☑ Chain inserting / removing tools
- ☑ Drill fixtures for slide rail
- ☑ Riveting Tool
- ☑ Files
- ☑ M8 ratcheting socket wrench
- ☑ Screwdriver
- ☑ Pliers
- ☑ Knife (for cutting off plastic screw head or burr of slide rail)
- ☑ Soft head hammer
- ☑ Clamping tools (for chain installation and dismantling)
- ☑ Level

**Power Tools**

- ☑ Hand Drill
- ☑ Drill bit



**Standard Fasteners**

M8 = Washer, Counter sunk screw, Cap screw, Nut, Lock Nut

M6 = Washer, Counter sunk screw, Cap screw, Nut, Lock Nut



**Connecting Strip**

Use for joining conveyor beams end-to-end; use Allen key and set screws to tighten the connecting strip to the beam.



**Square Nut**

Slide into T-slot of Flextrac Series conveyor and support beams for attaching accessories



**T-bolt**

Use when attaching support brackets, guide rails and drip tray to the conveyor beam

**The basic Flextrac Series conveyor structure consists of five component groups:**

- ✔ Conveyor beams, Drive Units, Idler Units and Bends
- ✔ Conveyor Guide
- ✔ Structure System
- ✔ Conveyor Accessories
- ✔ Safety

## ▷ Cutting Flextrac Series Beam

*If you have ordered 3m beams, they will need to be cut into suitable lengths before assembly. Study your drawing to determine the beam lengths required before cutting.*

- ✔ **Saw requirements:** Use miter saw for aluminum profile cutting at a high speed for nice, clean cuts. The saw should have the ability to cut the largest profile in one single cutting action.
- ✔ **Working site:** You should use a special area for cutting beams in order to keep the assembly area clean.
- ✔ **Quality of cut:** If burrs are evident, they must be removed prior to assembly. Make sure the cut is straight for proper assembly
- ✔ **Safety:** All safety precautions issued by the cutting saw manufacturer should be followed at all times.

The first step in the assembly process is to assemble the support structure, which consists of feet, support beams and beam support brackets. Most conveyor support designs are based on vertical support beams, combined if necessary, with horizontal support beams. There are also a number of different feet and beam support brackets, so check which ones are suitable to use in your application.

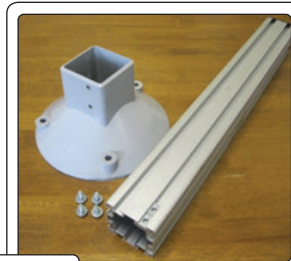

**1** Insert hex head screws and washers into the holes on the side of the foot. Use the screws to fasten foot connecting strips or square nut to the inner side of the foot.

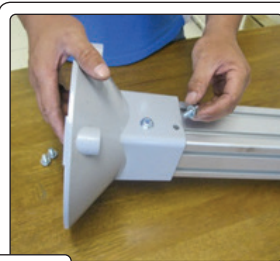

**2** Slide the connecting strips or square nuts into the structural beam T-slots.

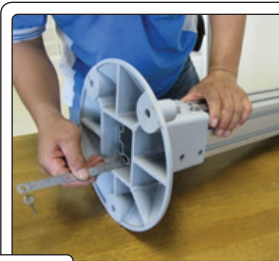

**3** Raise the beam from the bottom of the foot approximately 30mm, to allow for height adjustment later in the assembly.

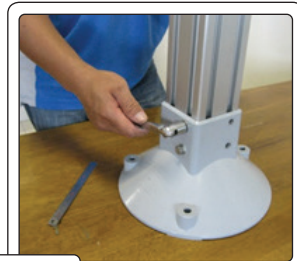

**4** Tighten the screws using a wrench.

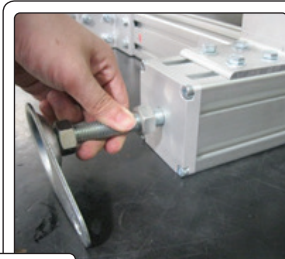

**1** Thread the holes using 6mm tap. Attach the support bracket to the beam by inserting 4 socket head cap screws into the holes on the support bracket. Tighten the screws using an Allen key.

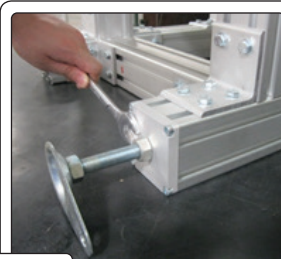

**2** Screw the foot cap onto the support bracket.

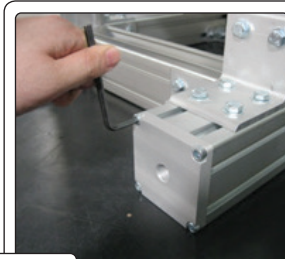

**3** Tighten the nut using the wrench.

There are various types of support brackets; each is connected to the structural beam in different ways.

Angle Bracket Installation

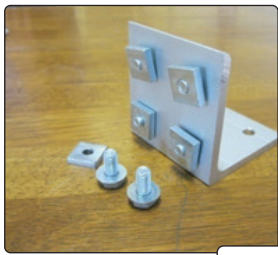

**1**

Insert the required number of square nuts into the structural beam T-slot. Mount the angle bracket using screws and washers.



**2**

Mount the angle bracket to the transverse beam in the same manner. Tighten all screws.

Connecting Plate Installation

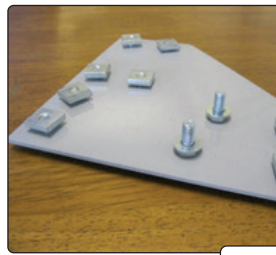

**1**

Insert the required number of square nuts into the structural beam T-Slot.

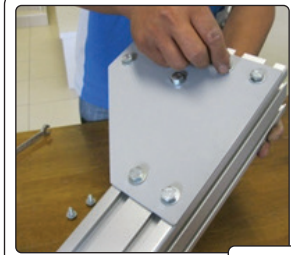

**2**

Mount the connecting plate using screws and washers.

▷ Mounting Conveyor Beam Support Bracket



**1**

Attach screws, square nuts and washers to the support bracket before mounting. Slide the square nuts of one support bracket into the support beam T-slots. Tighten the screws. Make sure that the support bracket is aligned with the beam.



**2**

Insert the square nuts of the second support bracket into the support beam T-slots. Slide the bracket down so that it does not protrude above the support beam.



**3**

Use a soft hammer or mallet to mount an end cap on to the support beam.



**4**

Mount the first support bracket to the conveyor beam. Pull the second bracket up and insert the T-bolts into the conveyor beam T-slot. Tighten the nuts.

The next step is to connect the straight sections, drive units, idler units and bends to each other. Connect all conveyor beams according to instructions below.



**1** Connect two conveyor beam ends by inserting connecting strips into the beam T-slots. Use two connecting strips per beam joint.



**2** Make sure that the set screws do not prevent the connection strips from sliding into place.



**3** Tighten the set screws using an Allen wrench.

 *Note: Assemble the entire conveyor beam structure in the same way. If the conveyor beam is too long to mount onto the support structure in one continuous length, assemble shorter lengths and connect them to each other once fastened to the support beams.*

Drive Unit Installation



**1** Loosen the four set screws that are inserted into the drive unit connecting strips. Insert the connecting strips into the T-slot of the beam you want attached to the drive unit. Make sure the set screws do not prevent the connecting strips from sliding into place.

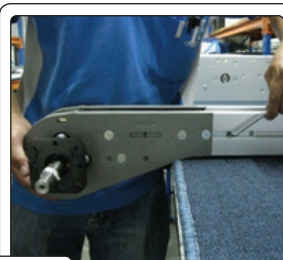

**2** Tighten the set screws using an Allen wrench.

Idler End Installation



**1** Insert the idler unit connecting strips into the T-slots of the beam end and tighten it.



**2** Tighten the set screws using an Allen wrench.

The slide rail is attached to the sides of the conveyor beam to reduce chain friction where the chain would otherwise be in direct contact with the beam profile. It is very important that the slide rail is installed properly, so that the chain can run without disruption.

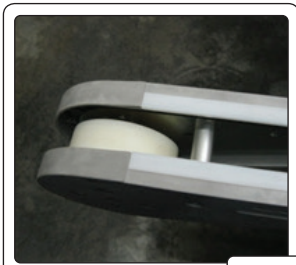

**1**

Start the slide rail assembly at an idler end unit. Separate the top and bottom flange of the slide rail at the end of the rail and press into place.

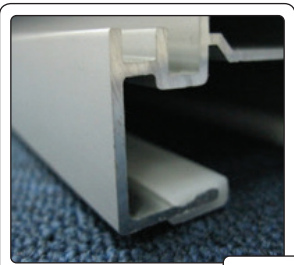

**2**

Ensure the slide rail is properly mounted and snaps onto the beam. The flanged edge of the siderail should snap over the flange on the inner edge of the beam.



**3**

Use the slide rail assembly tool to press the slide rail into place. One end of the tool is used when slide rail is mounted onto first side of the beam and the other end is used when mounting slide rail onto the second side.

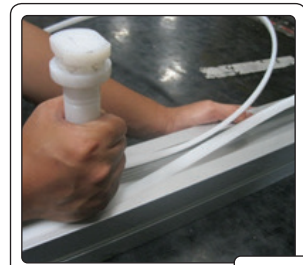

**4**

Slide rail should be installed on both top and bottom of beam (unless top running chain only).

▷ Joining Slide Rail



**1**

Cut both slide rail ends at 45° angle. The beginning of the new slide rail section in the direction of travel should receive a second cut at a slightly steeper angle.

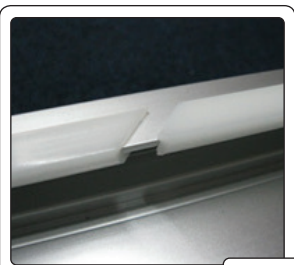

**2**

Allow a space of approximately 10mm between two slide rail ends.

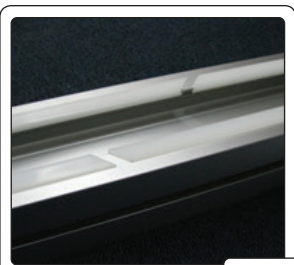

**3**

Do not place two slide rail joints opposite each other. Make sure there is a distance of at least 100mm between them to make sure the chain run smoothly (this does not apply at idler end or drive unit; these joints are always parallel).







**1** Cut the slide rail end at 45° angle on the inner radius of the bend.

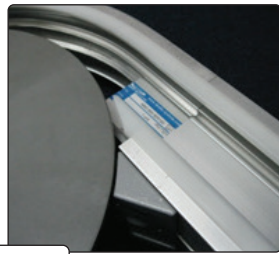

**2** The slide rail must be longer than the conveyor beam itself and there should be a 10mm gap between the slide rail and the wheel. Ensure the end of the slide rail is not bent up or down.



**3** Cut the slide rail at 45° angle with a short back cut. The slide rail must be longer than the conveyor beam itself and there should be a 2mm distance between the slide rail and the wheel.



**4** On the outer bend, make sure that the slide rail is properly connected to the conveyor beam profile.

 Note: Diagram below shows cross-section of conveyor beam after slide rails are installed for different size of frames.

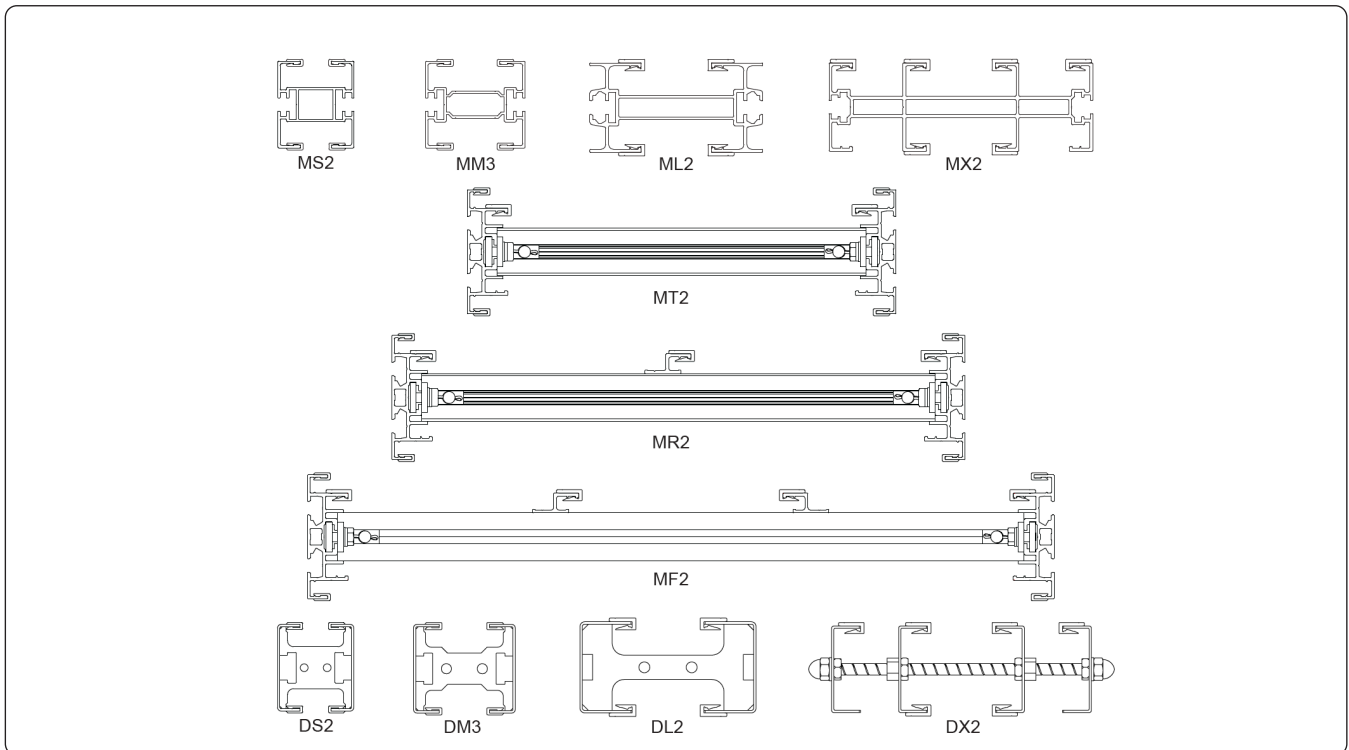

**Try to let the slide rail run in as many continuous lengths as possible, except in circumstances stated below:**

- It is recommended to use short slide rail sections (approximately 2m to 3m) where chemicals may have an effect on the slide rail composition.
- It is important to cut the slide rail and allow for elongation in high load areas. Cuts are required in wheel bends, by idler units and where the conveyor will be heavily loaded, especially by drive units. This prevents the slide rail from expanding into the drive unit, which may lock the chain.
- Never join slide rail in plain bends or vertical bends, since forces are higher on the slide rail in these sections. Instead, place the joint before the bends.
- Avoid joining slide rail on top of conveyor beam joints.



*Applicable for MS2 and MM3 only  
MS2 SR 25 Slide Rail Shown*

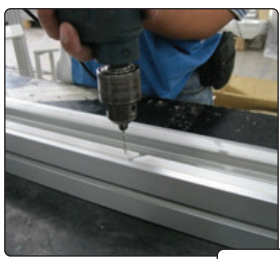

**1**

Drill two holes near the beginning of each slide rail section. Use the drill fixture to ensure clean-cut holes and correct location of the holes. The holes must be at the beginning edge of the joint piece, in the direction of travel, to hold slide rail in place when conveyor is in use. Use a well-sharpened drill bit.



**2**

Use a countersink to deburr and countersink the holes. Also ensure no metal filings are left underneath the slide rail.

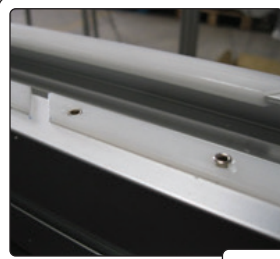

**3**

Insert rivets in the holes, using rivet crimping tools to crimp the rivets

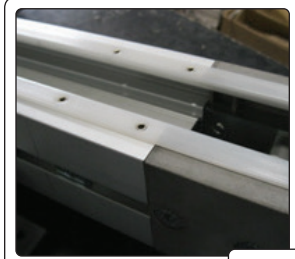

**4**

Check that rivets do not protrude over surface of slide rail. Check both top and bottom surface of slide rail for protruding metal.



**5**

Keep a distance of approximately 30mm between rivets and idler unit in case the idler end must be removed after conveyor system assembly.



Applicable for ML2 and MX2 only  
MS2 SR 25 Side Rail Shown

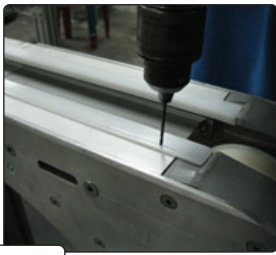

**1** Drill two holes near the beginning of each slide rail section. Use the drill fixture to ensure clean-cut holes and correct location of holes. The holes must be at the beginning edge of the joint piece, in the direction of travel, to hold slide rail in place when conveyor is in use. Use a well-sharpened drill bit.

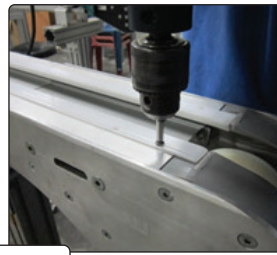

**2** Use a countersink to deburr and countersink the holes. Also make sure no metal filings are left underneath the slide rail.

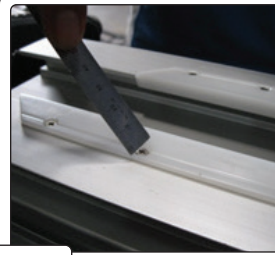

**3** Insert screws in the holes, using screw bit and hand drill to tighten the screws.

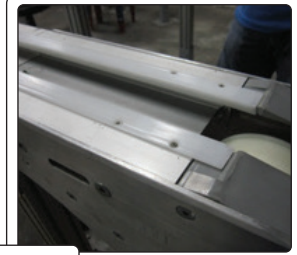



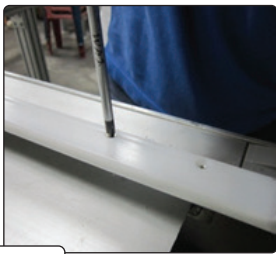

**4** Check that screws do not protrude over surface of slide rail. Check both top and bottom surface of slide rail for protruding metal.

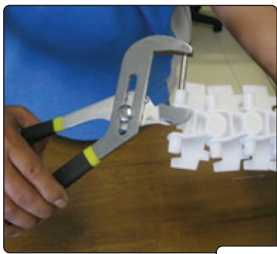
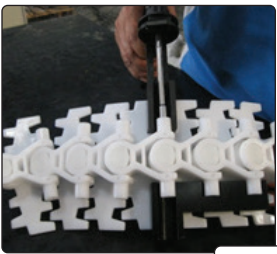
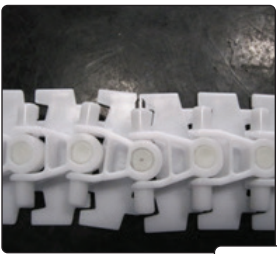

**5** Keep a distance of approximately 30mm between rivets and idler unit in case the idler end must be removed after conveyor system assembly.

 <p><b>1</b></p> <p>Insert the plastic pivot with the slot facing outward.</p>	 <p><b>2</b></p> <p>Insert the steel pin halfway, using a pair of pliers. Always use new steel pins and plastic pivots when joining chain ends.</p>	 <p><b>3</b></p> <p>Line the Flextrac Series chain tool up with the pin. Slowly depress the trigger until the pin seats.</p>	 <p><b>4</b></p> <p>Check that the chain is flexible at the joint and that the pin does not stick out or protrude through the other side.</p>
---	--	--	--

▷ Installing Chain

 <p><b>1</b></p> <p>Insert the chain into the underside of the drive unit. Ensure the chain will be moving in the correct direction, as indicated by the arrow located at the side of all chain links.</p>	 <p><b>2</b></p> <p>Feed the chain along the conveyor by pulling it through the idler unit and back to the drive unit</p>	 <p><b>3</b></p> <p>Join the chain ends.</p>	 <p><b>4</b></p> <p>Stretch the chain and remove links if necessary so that the chain exhibits some slack at the drive unit. Connect the chain ends.</p>
--	---	---	--

▷ Length Adjustment of the Conveyor Chain

1. Adjustment of the conveyor chain is carried out at the drive end of the conveyor.
2. Remove the chain catenary protection plate.
3. The conveyor chain should be tensioned within the conveyor system by pulling down the conveyor chain at the chain catenary in the underside of the drive unit. Clamp across the conveyor chain to trap the chain on the beam profile. The clamp should be placed over the edges of the drive unit to reduce the risk of damage to the aluminium profile.
4. Remove all slack links from the conveyor chain using chain insertion tool.
5. Rejoin the conveyor chain using a new steel pin and plastic pivot.
6. Remove the chain clamp and replace the catenary protection plate.

Guide rails are used to guide products being conveyed, but also to prevent them from falling off the conveyor.

Guide rails are supported by guide rail brackets attached to the sides of the conveyor beam. Follow the mounting instructions for the type of bracket used in your application.

Brackets should be placed approximately 500 to 1000 mm apart depending on type of product and if accumulation occurs or not. If brackets are spaced at greater distances than 1000 mm, there is a possibility that guide rails will become deformed due to excessive force.

### Mounting Guide Rail Bracket (Polyamide) ◀



**1** Insert square nut into T-slot of the beam. Fasten a guide rail bracket using hex head screw and washer.



**2** Attach a guide rail tube and guide rail support to the bracket. Tighten the nut or hand knob.



**3** Attach the guide rail to the guide rail support. Tighten the screw.

Note: Spacers can be added to increase side guide width. Use long bolt when mounting the bracket support and distance spacer to the conveyor beam. The length of the bolt depends on the number of spacers added.

### Mounting Guide Rail Bracket (Aluminum Distance Tube) ◀



**1** Insert square nut into T-slot of the beam. Insert set screw to the square nut.



**2** Tighten the distance tube to the set screw.



**3** Attach the guide rail bracket to the distance tube. Tighten the screw.

Attach the guide rail to the guide rail support. Tighten the screw.



**4** Different distance tubes are available to increase side guide width.



**1**

Connecting sleeves are fastened to the guide rail ends with set screws and an Allen wrench. Make sure you place the connecting sleeves on the outer side of the guide rail.

▷ Mounting Guide Rail Cover



**1**

To prevent products from being scratched, a plastic guide rail cover can be snapped onto the inside of the guide rail.

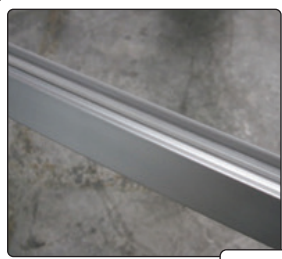

**2**

Make sure that all cover joints are smooth, so that products do not get caught or damaged. Do not join covers on top of guide rail joints.

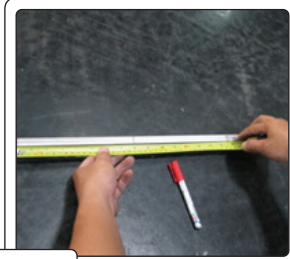
**1**

Mark the length of the rail to be bent. Leave an approximately 200mm straight section at each end.

**2**

Place the rail horizontally between the top wheel and the lower wheels. When bending guide rail, you should start bending from the center of the required radius.

**3**

Operate the crank to run the rail back and forth while lowering the upper wheel step by step until the desired radius and angle is achieved.

 To calculate the length of guide rail to be bent, use formula below:

$$L = (2\pi \times r \times \alpha) / 360$$

Where, L = length of bend, r = radius,  $\alpha$  = bend angle

If multiple bends with the same radius are to be made, note the final position of the upper wheel is indicated to make sure correct radius of subsequent rails. It is possible to bend angles up to 180°, minimum radius is 100mm.

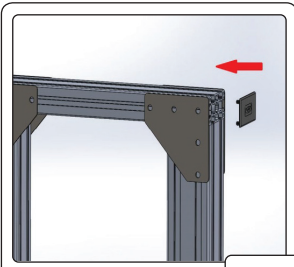

1  
Insert end cap on both sides of the beam using a soft hammer.

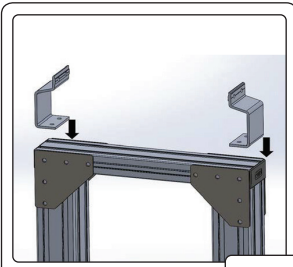

2  
Place the support bracket in place. Do not tighten the screws.

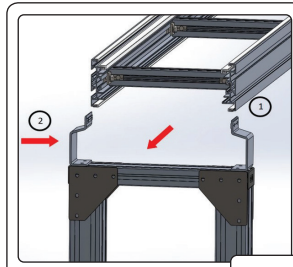

3  
Mount the first support bracket to the conveyor beam. Pull the second bracket up and mount the second support bracket to the conveyor beam. Tighten the screws.

▷ Assembling Conveyor Beams

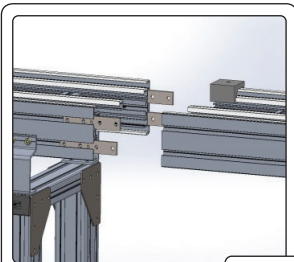

1  
Connect two conveyor beam ends by inserting connecting strips into the beam T-slots. Use two connecting strips per beam joint.

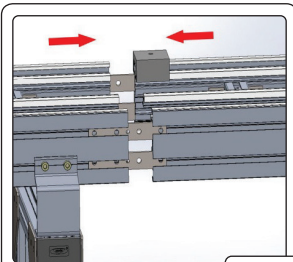

2  
Make sure that the set screws do not prevent the connection from sliding into place.



3  
Tighten the set screws using Allen wrench.





This section shows the method to mount drive units to the frame structure. All drives come with connecting strips. Attach them to the conveyor beam using an Allen wrench and the set screws that are included.

**Remember!**  
Conveyor belt should always be pulled, not pushed, by the drive unit.

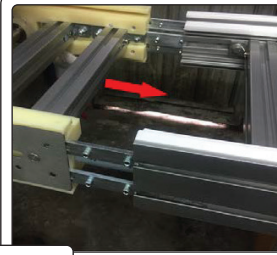
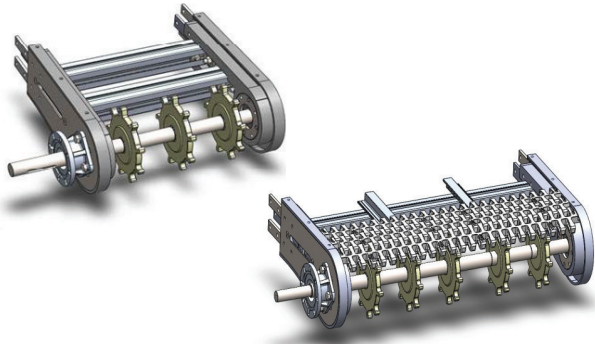

**1** Loosen set screws included in drive unit connecting strips. Insert the connecting strips into the T-slots of the beam you want to attach to the drive unit. Make sure that the set screws do not prevent the connecting strips from sliding into place.

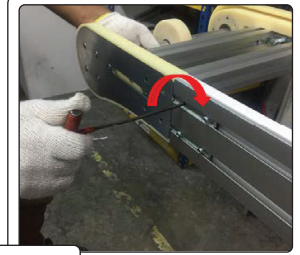

**2** Tighten the set screws using an Allen wrench.

 *Note: Drive units should be mounted with a support leg as shown below.*

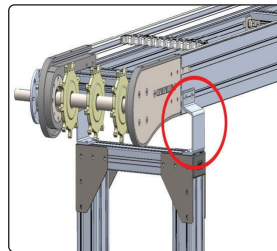

This section shows the method to mount idler ends to the frame structure. All idlers come with connecting strips. Attach them to the conveyor beam using an Allen wrench and the set screws that are included.

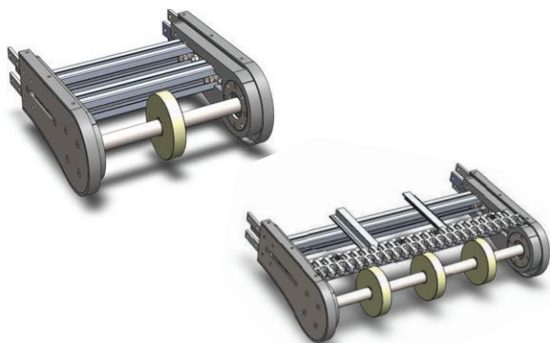

**1** Insert the idler unit connecting strips into the T-slot of the beam end.



**2** Secure the idler end to the beam using an Allen wrench to tighten the set screws.

To eliminate the risk of accidents, it is important to be aware of certain areas of the conveyor where special caution is required during installation, operation and maintenance. Some areas present a higher danger to personal safety and because of this various kinds of safety devices must be installed.

- ☑ All pinch and shear points as well as other exposed moving parts that present a hazard to employees at their workstations or their passage ways must be safeguarded.
- ☑ Cleated conveyor chains are more susceptible to creating pinch and shear points than plain chain.
- ☑ When two or more pieces of equipment are interfaced, special attention must be given to the interfaced area to ensure proper safeguarding.
- ☑ For overhead equipment, guards must be provided if product may fall off the equipment for some reason. The same applies to all incline, decline and vertical conveyors.

## ▷ **Safeguarding**

---

- ☑ Locate hazardous area out of reach of the personnel involved
- ☑ Use guards, or mechanical barriers, preventing entry into the hazardous area or protecting against falling goods.
- ☑ Control devices should prevent or interrupt hazardous conditions
- ☑ Use warnings instructions, sounds or light signals to alert of hazardous conditions
- ☑ Warnings shall be used when other means of safeguarding will impair the function of the installation

**Lubrication**

The conveyor chain is lubrication free. However, for some specific applications where the operating environment is particularly hostile, regular lubrication of the slide rail/conveyor chain will result in a lower coefficient of friction, longer life and reduced running cost. Use a silicon-based lubricant.

**Wear**

The amount of wear on a conveyor depends on a number of factors, such as:

- ☑ Chemicals
- ☑ Plain bends
- ☑ Speed
- ☑ Contamination
- ☑ Running time
- ☑ Product accumulation
- ☑ Temperature
- ☑ Load, contact pressure
- ☑ Sharp or rough products

Try to minimize the running time for the conveyor by stopping it when there is nothing to transport. Multiple horizontal and vertical plain bends in a conveyor will often result in increased wear. One reason is that the friction losses are large in plain bends. Also, the contact surface between chain and slide rail is small and the chain pull is acting towards the slide rail in the bends.

**Break-in Period**

Two or three days are recommended as a break-in period. During this time, the conveyor should be removed and cleaned two to three times to remove dust. Use warm water (around 120° F), using soap if necessary. After cleaning, re-install the chain. After break-in period wear will be minimized unless particles from product or process reach the conveyor continuously.

**Chain Elongation**

During the break-in period, regular checks should be made for elongation of the conveyor chain. This is especially important if the conveyor is transporting high loads or is of long overall length. Regular inspections of the chain elongation are important. The chain should be shortened after first 40 hours of running time.

This maintenance manual allows the users to maintain the conveyor in a manner which will ensure safe maintenance, smooth operation and maximum life span of the system. Please read and understand this manual before operation or performing maintenance on the system. Documentation may not be reproduced in any form without the written permission of the manufacturer.



***DO NOT ATTEMPT MAINTENANCE ON ANY CONVEYOR  
WHILE IT IS IN OPERATION***



**Before Maintenance**

- 1) Maintenance functions can only be performed after all power is off. Stop motors and follow lockout/tagout procedures.
- 2) Pneumatic power must be disconnected and any pressure accumulation must be released.
- 3) Never work on a conveyor while it is running, unless maintenance procedure requires operation. When a conveyor must be operating to perform the maintenance, allow only properly trained maintenance personnel to work on the conveyor.
- 4) Remove all remaining product from the conveyor system.
- 5) Staff affected must be informed that maintenance work is being undertaken.

**During Maintenance**

- 1) Do not wear loose clothing while performing maintenance on operating equipment.
- 2) Be aware of hazardous conditions, such as sharp edges and protruding parts.
- 3) When using hoists, cables or other mechanical equipment to perform maintenance, use care to not damage conveyor components. Miss-aligned parts are dangerous as conveyor is started after maintenance is completed.
- 4) Keep area clean. Clean up lubricants and other materials before starting conveyor.
- 5) Must equip with Personal Protective Equipment (PPE) such as safety glasses, safety shoes, safety helmet etc when performing maintenance.

**After Maintenance**

- 1) Before starting any conveyor after maintenance is completed, walk around the equipment and make certain all safety devices and guards are in place, pick up tools, maintenance equipment and clear any foreign objects from equipment.
- 2) Make certain all personnel are clear of the conveyor and made aware that the conveyor is about to be started.
- 3) Only authorized personnel should be permitted to start any conveyor following maintenance or emergency shut-off.

**System Maintenance** ◀**Introduction**

This manual is designed to provide assistance for your planned maintenance schedule. It may become evident that the suggested maintenance interval can be extended to accommodate your local environmental conditions.

Maintenance of Flexrac Series conveyor systems shall only be done by competent/proper trained personnel who are familiar with Flexrac Series products. If there is any doubt, please consult your Flexrac Series supplying agent.

**Introduction**

This maintenance manual contains the maintenance guide for Flextrac Series standard components. For non Flextrac Series components such as motors, sensors, pneumatic components, control systems etc., the manufacturer maintenance instructions apply. This manual does not include maintenance instruction for equipment customer has chosen and specified for fitting to the installation.

Maintenance of Flextrac Series conveyor systems shall only be performed by competent and properly trained personnel who are familiar with Flextrac Series products. If there is any doubt, please consult your Flextrac Series supplying agent.

**Recommended Spare Part List**

Recommended spare parts list is shown in Appendix A. User of Flextrac Series conveyor system should keep at least a complete set of recommended spare parts. Spare parts may be obtained by contacting QC Conveyors or your local distributor.

**Maintenance Schedule and Inspection Guidelines**

A suggested maintenance schedule and inspection guidelines are shown below in Maintenance Guidelines. It may become evident that the suggested maintenance interval can be extended to accommodate your local environmental conditions.

**Warranty**

Flextrac Series conveyors are covered by warranty as agreed within the Order Acknowledgement

▷ Maintenance Guidelines

**Maintenance Schedule**

Flextrac Series conveyors are designed to run 24 hours per day, 7 days per week, with minimum maintenance. For non Flextrac Series components such as geared motors, sensors, pneumatic components, control systems etc., the manufacturer maintenance instructions apply.

#	Section	General Checks	Operating Hours/ Time Interval
1	Drive Unit	Check sprocket, chain return guide, chain guards and lubrication	First 50, 250 and 500 hours. Then every 500 hours.
2	Idler End	Check chain guides and chain guards	Every 1000 hours.
3	Chain	Clean	Every Day
		Check for wear or cracks	Every 2000 Hours
		Check tension	First 40 and 200 hours, then every 1600 hours
4	Slide Rails	Check slide rails at horizontal and vertical bends	Every 200 Hours
		Check and clean slide rails of the conveyor system	Every 1500 Hours
5	Safety Features	Check for function as required	At least once a year

In the course of conveyor operation, periodic inspection of the conveyor system is required to prevent of any breakdowns and failures Flextrac Series conveyors should be inspected while the system is running as well as when it is shut down.

Symptom	Cause	Correction
Jerky Running	Damaged or badly fitted slide rail	Inspect and replace as necessary
	Conveyor chain is too tight/loose	Tension conveyor chain correctly
	Dirty conveyor	Clean conveyor chain and slide rail. Lubricate with silicone based lubricant.
Noise	Worn or damaged bearings in drive unit	Check/replace drive unit
	Damaged/badly fitted slide rail	Check that chain is free running, especially at slide rail joints
	Excessive conveyor speed	Lower speed. Check actual load against recommended loading.
	Incorrect conveyor chain tension	Tension conveyor chain correctly
Motor overheating on drive unit	Overloaded conveyor	Remove products from conveyor and test. Check actual conveyor load against recommended loading.
	Gearbox leaking oil	Check output shaft seal and area around motor/gearbox interface
	Dirty conveyor	Clean the chain and slide rail
Abnormal wear on plastic parts	Overloaded conveyor	Remove products from conveyor and test. Check that chain is free running. Check actual conveyor load against recommended loading.
	Ambient temperature too high	Check recommended temperature for conveyor
	Chemicals in the environment are affecting plastic parts	Check Flextrac Series catalogue (section TR) for listing of incompatible chemicals
	Damage due to contamination	Clean the system
	Particles, swarf etc.	Remove source of contamination
Drive unit is running, conveyor chain is not moving	Friction disc in slip clutch is worn or contaminated	Check and replace if necessary
	Transmission products are not fitted	Check and fit

**General Check on Drive Unit**

Carry out a general inspection of the drive unit:

- 1) Check that the protective covers for the conveyor chain are complete and firmly in place.
- 2) Replace damaged/worn parts.

**Guide for the Conveyor Chain.**

The purpose of the guide for the conveyor chain is to guide the return chain correctly into the drive unit.

Fully guided drive units do not have guides. On these, no slack is allowed at the drive unit since the conveyor chain is being controlled all the time. Special attention must be given to chain elongation in conveyors of this configuration. Gripper conveyors, for example, are typically configured this way.

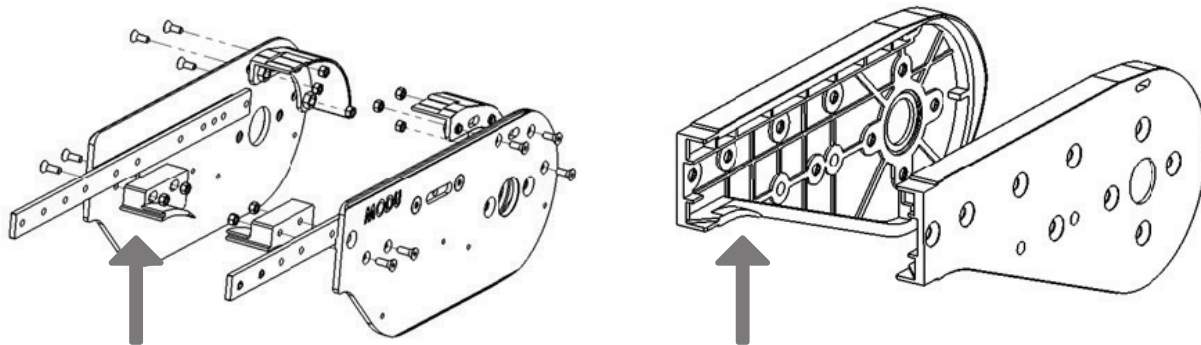

**Suspended Drive**

The suspended drive should be checked and lubricated after 50, 250 and 500 hours of operation, and then every 500 hours.

If the suspended drive is not fitted with a tensioner it should be checked at this time. At the same time as the tension is checked, the roller chain must be lubricated.

If the drive is fitted with a chain tensioner, lubrication of roller chain should only be carried out at the stated interval. The condition of the chains must be checked at the same time.

**Gear Motor**

The gear motor should be checked in accordance with the instructions from the manufacturer.





Caution: Only warm water (50°C), with soap if necessary, may be used for cleaning conveyor chain.

Friction Chain, Cleated Chain, Flocked Chain, Finger Gripper Chain, Box Gripper Chain and Wedge Chain and other special chains should be inspected regularly and any defective or dirty links must be replaced or cleaned.



Plain Chain

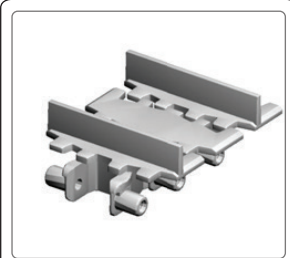

Cleated Chain

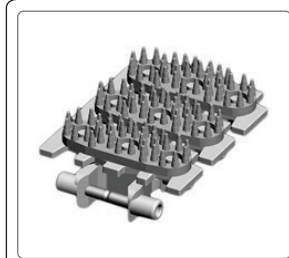

Finger Gripper Chain

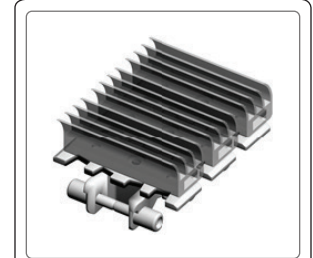

Wedge Chain

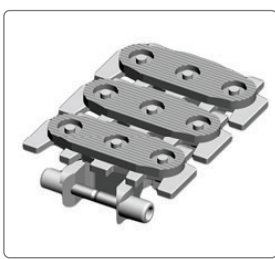

Friction Chain

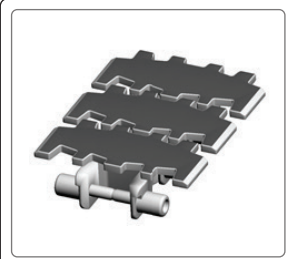

Flocked Chain

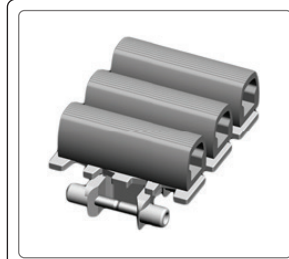

Box Gripper Chain

The chain is made of elastic material. The chain eventually stretches as the material creeps. The extent of the stretch depends on the traction force in the chain. The stretch shows itself as slack on the return side of the drive unit.

The tension of the chain should be checked after 40 and 200 hours of operation and thereafter every 1600 hours. In operation there will be some slack in the conveyor chain. How much slack is acceptable depends on the length of the conveyor chain. The most suitable place to check the slack in the chain is at the drive unit.



*The chain should be pre-tensioned while the conveyor is stationary, but must never be so tight that there is no slack during operation. There should be no appreciable slack on the chain when the conveyor is stationary. This can, however, vary depending on the total length of the chain. If there is too much slack, there will be excessive wear on the chain guides and the chain. This could be a risk for injury.*

If the slack on the conveyor chain is unacceptably high, it must be shortened by splitting the chain and removing the necessary number of links. If the conveyor has a fully guided drive unit with no chain slack take up, the elongation of the chain must be monitored even more carefully to ensure a trouble free operation.

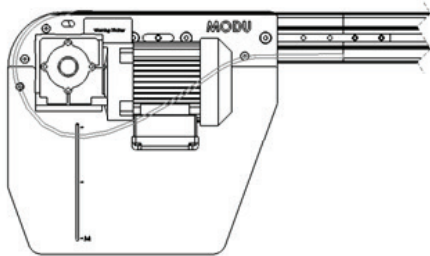

The conveyor chain does not need to show any slack when the conveyor chain is stationary

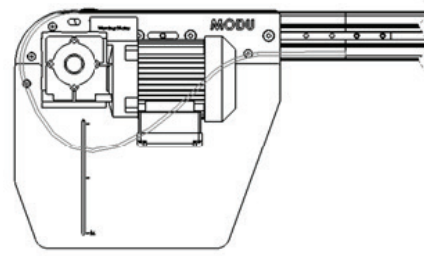

The conveyor chain must show some slack during operation

## Shortening the Conveyor Chain ◀

1. Make the bottom of the conveyor chain accessible.
2. Remove the steel pin (1) from the pivot (2). Use the pin insertion tool.
3. Remove the necessary number of links. *Note: With cleated or plain chains, pay attention to the divisions between links.*
4. Join the chain together with a new pivot. *Note: the old pivot should not be re-used. When the chain is divided, a new pivot must always be fitted.*
5. After inserting the steel pin, check that it is centered and that the chain easily bends at the fitted link.

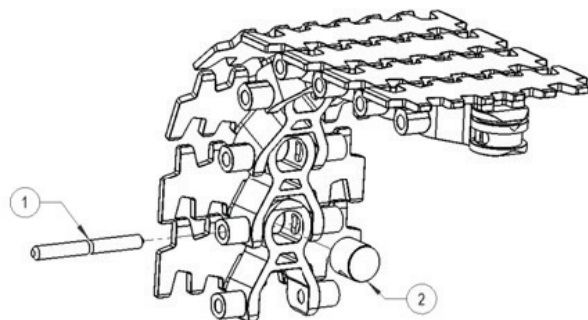

**Checking Slide Rail**

The condition of the slide rails is fundamental to the function of the conveyor. It is therefore essential that these are in good condition.

**Checking the Slide Rail with the Conveyor Chain in Place**

The slide rail must be checked after every 200 hours' operation. Carry out the check on a stationary conveyor with the chain in place.

1. Check the fastening points on the slide rail.
2. Check the joints on the slide rail. Below shows correct configuration of joints.
3. Check that there is a gap between the slide rails and that the joints are correctly fitted.
4. Check that the joints are not deformed.
5. Check that the slide rail has not been broken off.
6. Replace the slide rail if necessary.

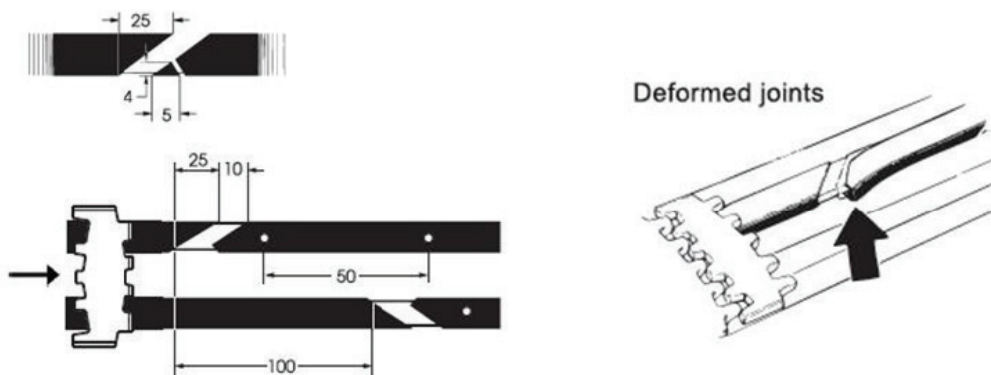
▷ **Conveyor Beams, Idler Ends and Bends**

The conveyor beams themselves do not normally require any regular inspection. Be observant for damage arising from external factors, warping or deformation. Deformation can cause the conveyor chain to jam, resulting in uneven running.

Idler ends and wheel bends do not normally require any special inspection, but they should be checked when the slide rails are inspected.

Large radius plain bends may have inner support rails fitted to the beam. Ensure that these rails (if fitted) are not worn, paying particular attention to the "lead-in" area.

**Safety features should be checked at regular intervals**

1. Check the chain guard for roller chain or timing belt transmission. This guard must always be in place when the conveyor is running.
2. Check the protective cover on the cleated chain conveyor return chain.
3. Drive units have slack protection for the conveyor chain. Ensure the slack protection plates are in place and that the chain does not slacken enough to hang below the “M” mark on protection plates.
4. There may be other types of guard which are specific to your installation and these must also be inspected.

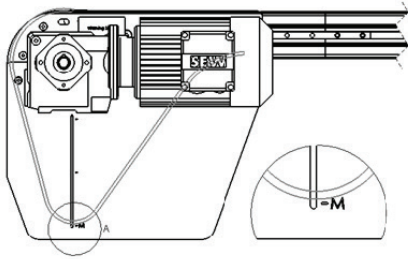

Slack must not hang below “M” mark conveyor chain is stationary

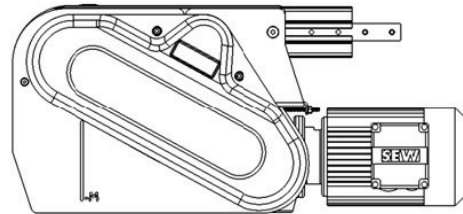

Chain guard for roller chain or timing belt

Replacement of Worn Conveyor Chain ◀

**Removal of Conveyor Chain**

1. Ensure that power to the drive motor is disconnected.
2. Disengage the motor; there are various methods depending on the type of drive unit.
3. Split the chain by removing the steel pin from the pivot. Use the special tool for insertion or removal (see Shortening Conveyor Chain section).
4. Pull out the chain.

**Removal of Conveyor Chain**

1. Run a sample, approximately 0.3m of conveyor chain through the installation in the direction of the conveyor. Check that the chain moves easily and correctly through the bends and idler ends. Check at the same time that there is enough space for chain.
2. Put the new conveyor chain in place. Check that the chain direction corresponds to the conveyor direction.

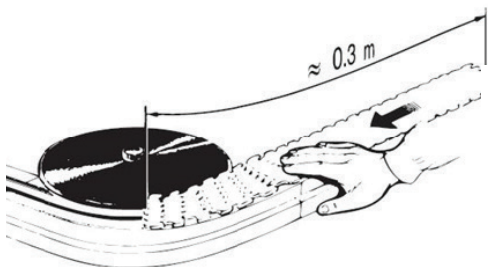

Checking of Conveyor Chain Space

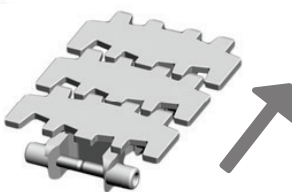

Conveyor Chain Direction

**Replacing Slide Rails**

It is very important to assemble slide rail correctly to ensure smooth system operation. Follow the illustrated instructions on the following pages carefully. Observe the following points:

1. Slide rail cutter – single cut pliers are suitable tools for cutting the slide rails.
2. Use slide rail mounting tools.
3. Use drill fixture.
4. Use a high quality drill bit to avoid forming a shoulder, preferably one which is intended for drilling aluminium.

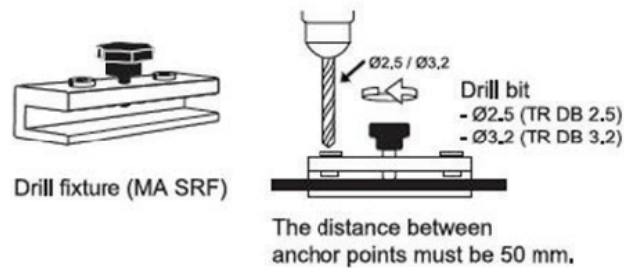
**Fitting Slide Rails**

1. The joints on the slide rails must have a distance of 10mm between them.
2. Joints may not be positioned in bends, or in the transition between two sections of beams.
3. The slide rails should normally be approximately 5m long on a straight conveyor beam. In a bend, the maximum length of slide rail should be 3m.
4. The joints should be positioned a minimum of 500mm before an idler end unit, drive unit or vertical bend. The slide rail must overlap the recess in the idler end and drive unit.
5. The inner slide rail after a wheel bend must be cut so that the cut surface is parallel to the wheel. In front of the wheel bend, the slide rail will normally be cut at 45°.

*Note: Check final slide rails visually, as well as running a section of conveyor chain through the installation area.*

The beginning of each slide rail section must be fixed to the beam, since the chain will cause the slide rail to be pushed forward. Slide rail which moves into a wheel bend or a drive unit can block the chain completely.

There are two different methods for fixing slide rail to the conveyor beam:

- Using rivets (MA RR 3), this is applicable for MS2 and MM3 series only (see previous pages for instructions).
- Using screws (MA RS 6.5), this is applicable for ML2 and MX2 series only



Drill through holes on slide rail.

1

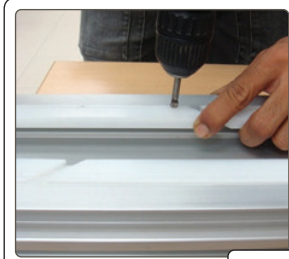

Countersink holes on slide rail.

2



Apply screws into the holes.

3

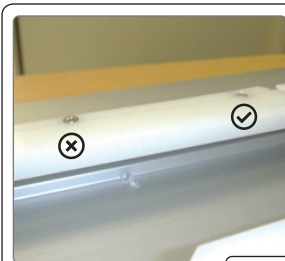

Check that the screw does not protrude over the surface of the slide rail. Check both top and bottom surface of slide rail for protruding metal.

4

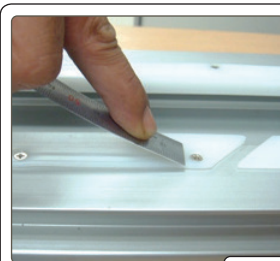

Complete fitting slide rail.

5

The beginning of each slide rail section must be fixed to the beam, since the chain will cause the slide rail to be pushed forward. Slide rail which moves into a wheel bend or a drive unit can block the chain completely.

There are two different methods for fixing slide rail to the conveyor beam:

- Using rivets (MA RR 3), this is applicable for MS2 and MM3 series only.
- Using screws (MA RS 6.5), this is applicable for ML2 and MX2 series only (see following pages for instructions).



**1** Drill through holes on slide rail.



**2** Countersink hole on slide rail.

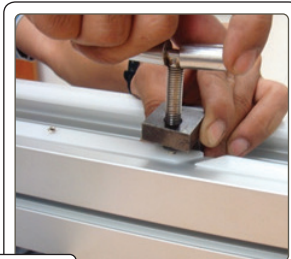

**3** Insert rivets in the holes, using rivet crimping tools (MA RC)

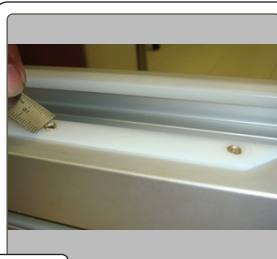

**4** Check that the rivets do not protrude over the surface of slide rail. Check both top and bottom surface of slide rail for protruding metal.

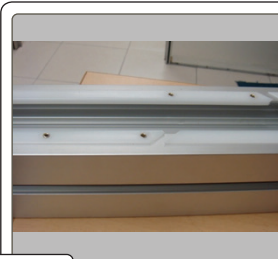

**5** Complete fitting slide rail.

# VISIT US ONLINE: QCCONVEYORS.COM

For more information on our available products visit us online. While you're there you will also have access to downloadable manuals, video tutorials, upcoming event information, and our powerful Conveyor Configurator.

## POWERED BY PROVEN PRODUCTS



### THE ULTIMATE USER FRIENDLY CONVEYOR

#### Automation Series

Single piece aluminum frame conveyors which feature a tension release tail, high speeds, low profile and a multi-piece frame option for conveyors over 12" wide. Automation Series conveyors are available in end drive, movable center drive and angled frame options.

### FAST, EFFICIENT CLEANING

#### HydroClean Series

Stainless steel frame conveyors designed for tool-less disassembly and easy, in-place cleaning. Available with NSF and BISSC Certifications; all models are built to NSF standards to minimize bacterial growth to accommodate clean rooms, food packaging, pharmaceuticals and washdown environments.

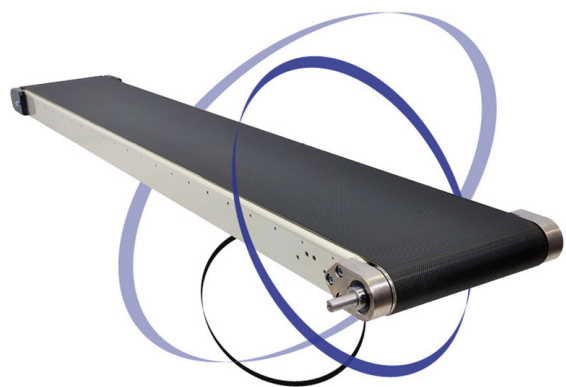
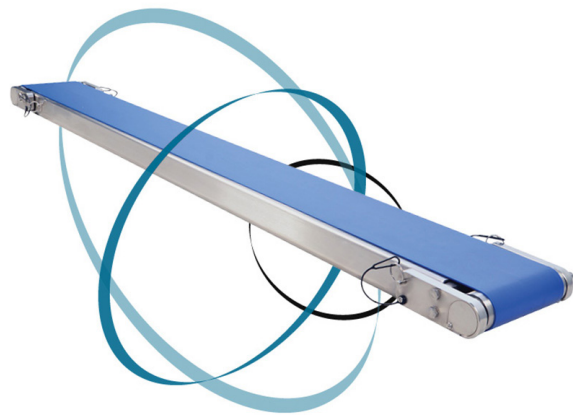

### VERSATILE AND RELIABLE

#### Industrial Series

Powder Coated Steel frame conveyors designed for a wide range of applications. Industrial Series conveyors are available as flat belt, plastic chain, embedded drive, heavy weights, and indexing options.